

## Mini Hand Dryer AK2803 Series

---

We take AK2803B as an example

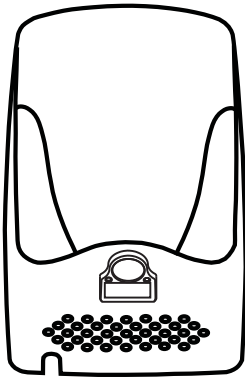

AK2803B

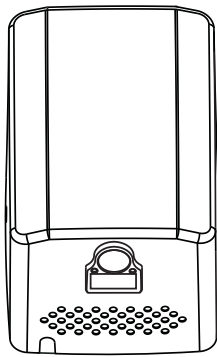

AK2803C

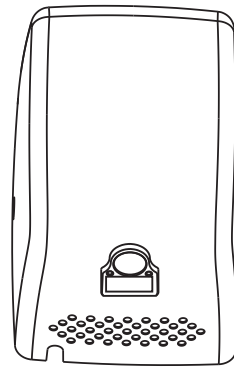

AK2803D

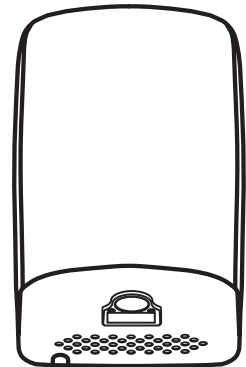

AK2803E





# Install method

## 1 connect the line

- When installing dryer without junction box, you should install above the right side of dryer two-hole standard outlet corresponds to hand dryer. The distance should be 20-50cm.
- Please embed junction box without cover in the installation location when directly connecting power cord is needed. Otherwise, power cord will be forced out of body and can not be properly installed.

1

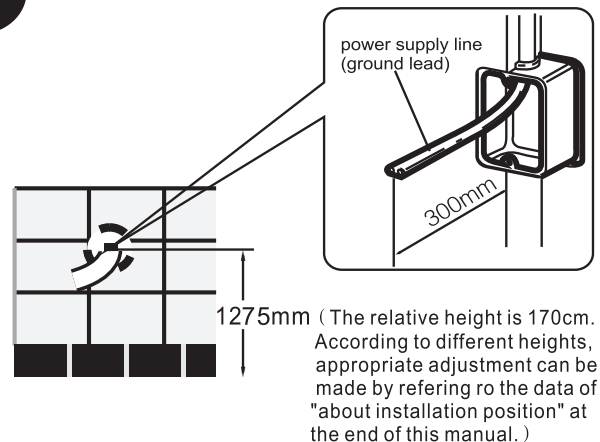

## 2 Shell remove

- Using Allen wrench from accessories bag to remove 2 countersunk screws from body shell.
- Pull the shell upward by hands to remove.
- ❗ Keeping the shell carefully avoiding scratching.

2

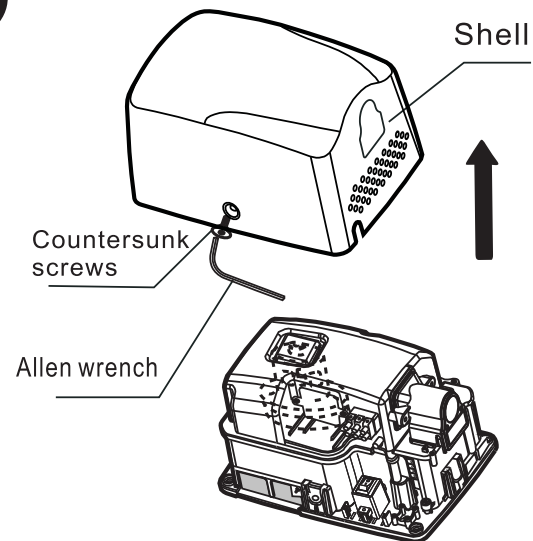

## 3 Machine installation

- As figure showed, the machine to be fixed on the wall by screws.
- The machine has been equipped with a power cord. If needing junction box for installation, the power cord must be removed.
- As figure showed, poking the thread hole of junction box by screw drivers, wire drawn out through thread hole to the terminal blocks to connect.
- ❗ When connecting, the wire length should exceed 2cm to terminal block. Fire line must be connected at **L** position of terminal blocks, null line connected at **N** position, earth line connected at

3

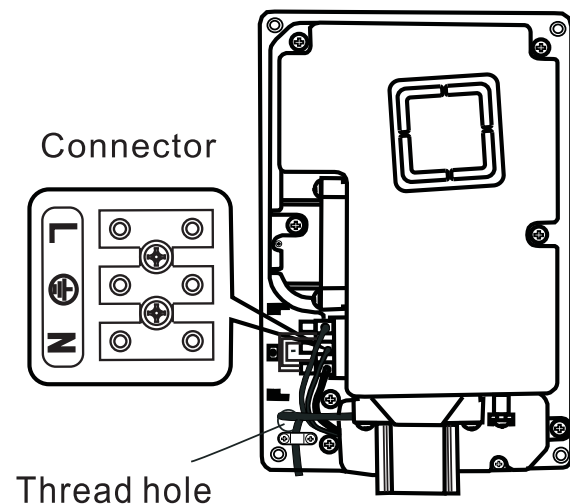

# Install method

**4**

**Shell installation**

- Tighten the 2 countersunk screws on the shell.

# Test run

	Steps	Confirm information	Check & Notice
1	Shake the machine gently	The machine is installed firmly without shaking	It will occur shaking and noisy when the machine doesn't install firmly
2	Confirm the power and voltage	Please use the rated Voltage	It will burn out machines or cause human accidents if the power use incorrect
3	Switch on the power	Close external power supply switch or insert the power plugs	Power socket must be match the machine plug Please check the power when the indicator light not bright
4	Slid in your hands to drying	High speed wind blow out	Please confirm whether your hands are far away from the sensor parts if there is no wind blowing out

