

GENERAL FEATURES

- Optimized plate achieve low IR
- 30% increased power output at 15 min
- Deep Discharge Recovery
- High Power Density
- Wide operating temperature

APPLICATIONS

- UPS & EPS
- Emergency lighting Systems
- Medical Equipment
- The office computer
- Cable TV Systems
- Alarm Systems



DIMENSIONS & WEIGHT

Length(mm)	196±1
Width(mm)	130±1
Height(mm)	155±1
Total Height(mm)	167±1
Weight(kg)	11±3%

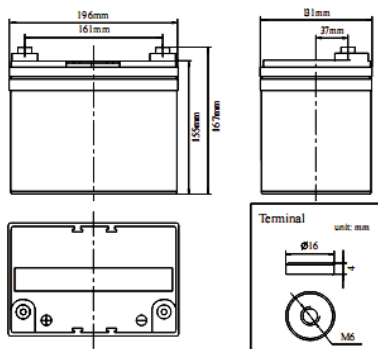

COMPLIED STANDARDS

IEC 60896-21/22	JIS C8704
YD/T799	BS6290 part4
GB/T 19638	UL 1989

TECHNICAL SPECIFICATIONS



Nominal Voltage		12V(6 cells per unit)
Design Floating Life @25°C		12 Years
Watts/cell@25°C(@15min,10.02V)		145W
Capacity @25°C	10 hour rate (3.4A,10.8V)	34Ah
	3 hour rate (9.9A,10.5V)	29.7Ah
	1 hour rate (25.8A,9.6V)	25.8Ah
Internal Resistance	Full Charged Battery@25°C	≤9.5mΩ
Ambient Temperature	Discharge	-20°C~50°C
	Charge	-20°C~50°C
	Storage	-20°C~50°C
Max.Discharge Current@25°C		510A(5s)
Capacity affected by Temperature (10 hr Capacity)	40°C	102%
	25°C	100%
	0°C	85%
	-15°C	65%
Self-Discharge@25°C per Month		3%
Charge (Constant Voltage) @25°C	Standby Use	Initial Charging Current Less than 8.5A Voltage 13.6-13.8V
	Cycle Use	Initial Charging Current Less than 8.5A Voltage 14.4-14.9V

BATTERY DISCHARGE TABEL

Discharge Constant Power per Cell (Watts at 25°C)

F.V/Time	5min	10min	15min	20min	25min	30min	45min	60min	90min	120min	180min	600min
1.60V	247.9	191.4	147.5	122.2	103.9	92.6	69.8	57.1	40.5	31.7	21.8	8.2
1.67V	243.3	187.9	145.0	120.7	101.9	90.9	68.5	56.1	39.7	31.2	21.7	8.1
1.70V	238.9	184.4	142.2	118.5	100.1	89.2	67.2	55.0	38.9	30.5	21.6	8.0
1.75V	234.3	181.0	139.5	114.7	98.2	87.6	66.0	54.0	38.2	30.1	21.4	7.9
1.80V	229.2	177.2	135.6	110.3	95.7	84.6	63.5	51.5	37.0	29.7	21.1	7.8

Discharge Constant Current per Cell (Amperes at 25°C)

F.V/Time	5min	10min	15min	20min	25min	30min	45min	60min	90min	120min	180min	600min
1.60V	123.3	95.0	73.0	60.6	52.7	44.6	33.0	25.8	18.6	14.9	10.5	3.7
1.67V	121.0	93.3	71.6	59.9	51.8	43.8	32.4	25.6	18.3	14.6	10.3	3.6
1.70V	118.8	91.5	70.3	58.7	50.8	43.0	31.8	25.2	17.9	14.3	10.1	3.6
1.75V	116.5	89.8	69.0	56.9	49.9	42.2	31.2	24.8	17.6	14.0	9.9	3.5
1.80V	115.1	88.4	67.7	55.3	47.9	41.3	30.9	24.3	17.1	13.6	9.6	3.4

Note The above data are average values, and can be obtained within 3 charge/discharge cycles. These are not minimum values. Cell and battery designs/specifications are subject to modification without notice. Contact **CBB** for the latest information.

PERFORMANCE CHARACTERISTICS

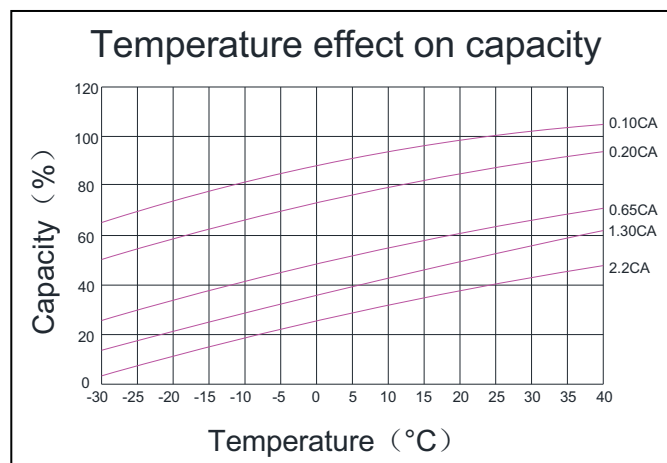
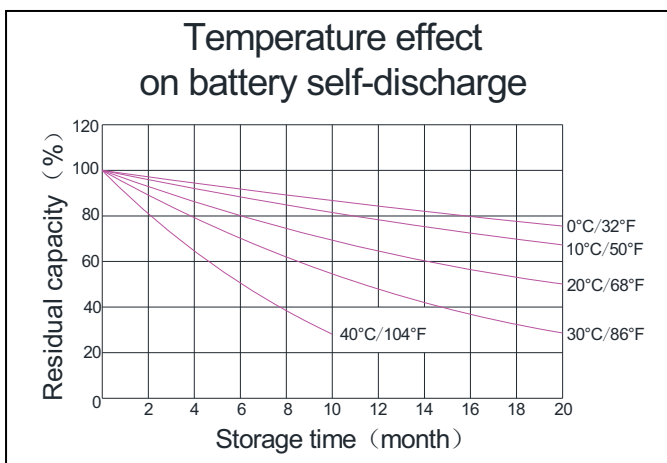
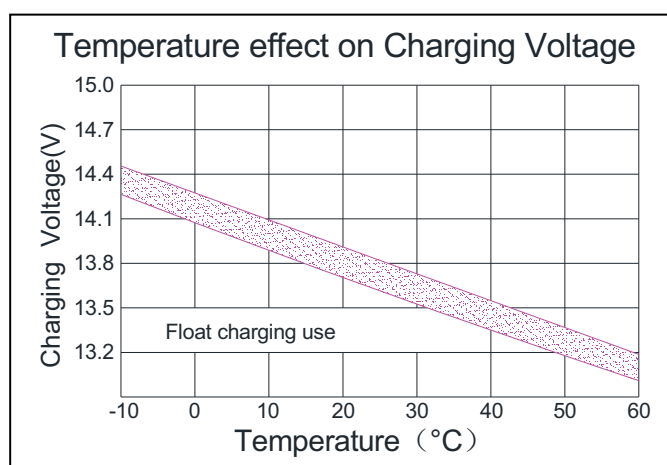
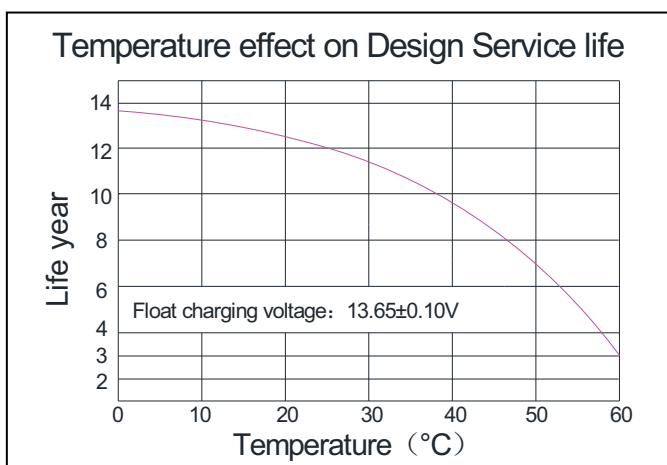
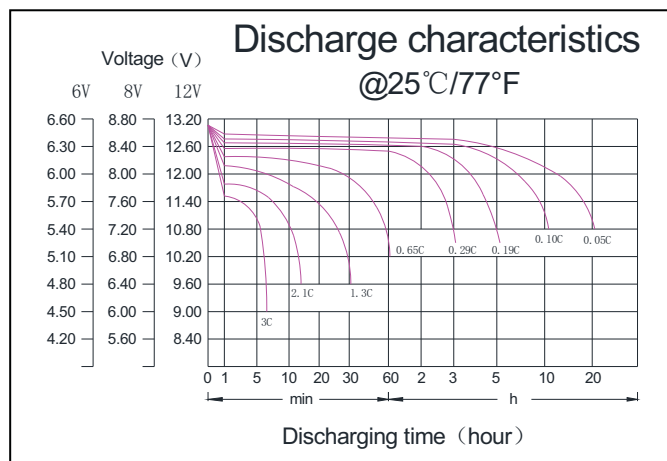
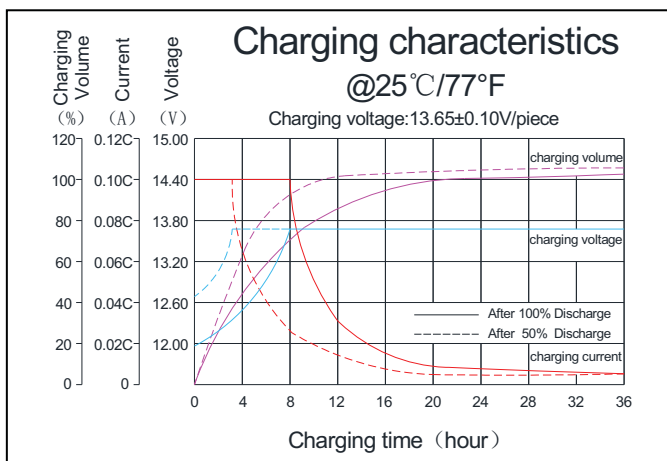

BATTERY CONSTRUCTION

Component	Positive plate	Negative plate	Container & Cover	Safety valve	Terminal	Separator	Electrolyte	Pillar seal
Features	Thick high Sn low Ca grid with special paste	Balanced Pb-Ca grid for improved recombination efficiency	ABS (UL94-V0 optional)	Flame Si-Rubbeand aging resistancer	Female Copper Insert M6(torque:4~6N.m)	Advanced AGM separator for high pressure cell design	Dilute high purity sulphuric acid	Two layers epoxy resin seal

CBB Battery Technology Co.,Ltd.

RM504,55 Hanxing Zhong Road,Zhongcun, Panyu,Guangzhou 511495 China
 Tel: +86-020-84888946 Fax: +86-020-62824569

Koyama®

www.cbb-battery.com