



Contents

Contents.	1
Important note.	2
Control elements.	3
Rear panel features introduction.	4
Rear panel features introduction.	5
Audio input and output connections.	6
Output Mode.	7
Professional Power Amplifier Specifications.	8

Important Note

WARNING NOTICES

SAFEGUARDS

Electrical energy can perform many useful functions, This unit has been engineered and manufactured to assure your personal safety. Improper use can result in potential electrical shock or fire hazards. In order not to defeat the safeguards, observe the following precautions for its installation, use and servicing.

Explanation of Graphical Symbols



**CAUTION
RISK OF ELECTRIC SHOCK
DO NOT OPEN**



**CAUTION
RISK OF ELECTRIC SHOCK :
OPEN ONLY IF QUALIFIED
AS SERVICE PERSONNEL**

**WARNING: TO PREVENT FIRE OR ELECTRIC SHOCK, DO NOT EXPOSE
THIS EQUIPMENT TO RAIN OR MOISTURE**

IMPORTANT NOTE

ATTENTION: This unit must be protected from damp because of the risk of fire and the possibility of electric shocks.

1. Make sure that you have the correct mains voltage. Only operate the unit at the mains voltage marked on the rear panel.
2. Make sure that nothing especially no metal objects are inserted into the device. This could result in electric shock or malfunction.
3. If the unit is subjected to extreme fluctuations of temperature e.g. On being transported from outside into a heated room, condensation can form. This unit should not be used until it has reached room temperature.
4. In the event of water or any other fluid being accidentally spilt on the unit switch the unit off immediately and send it to a qualified service workshop for inspection.
5. Make sure that the unit is always well ventilated and never exposed to direct sunlight
6. Do not use sprays to clean the unit as they have a detrimental effect on the unit and could ignite suddenly.
7. The machine use single power switch, please cut off the power before fix.
8. Please do not put the cup, vessel of flower or container above the machine, in case the leak out water then cause the leakage current off the machine.



Control elements

Front Panel

The front panel LED area includes the following indicators per channel:

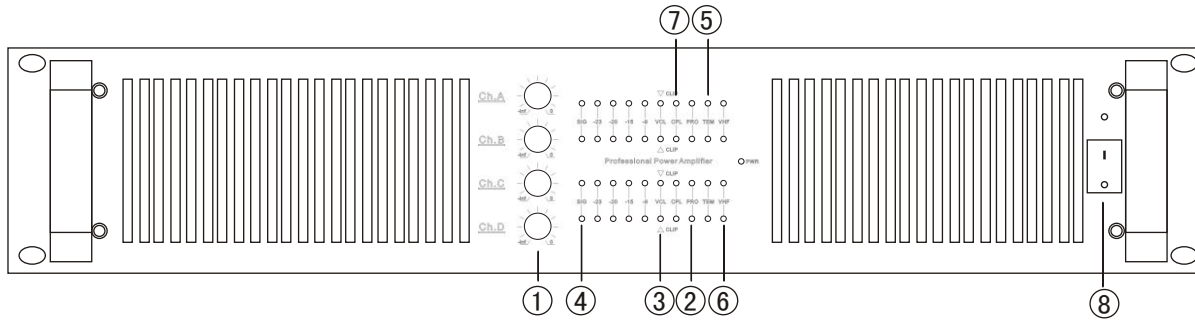

1. LEVEL CONTROL

Calibrated detente potentiometers to alter the total gain of the power amplifier. In order to avoid distortions in mixing consoles upstream, these controls should normally be positioned between 0 and 10. The calibrated markings show the additional attenuation directly.

2. PROTECT LED

protection under mute position.

3. CLIP/LIMIT INDICATOR

This indicator signals if the amplifier output is clipping or limiting. It has two different indication states:

If the clip limiter is engaged, it has a short time constant, and it illuminates briefly.

If the clip limiter is not engaged, it has an increased time constant, and it illuminates for a longer period.

4. SIGNAL LED

Green SIG Indicates output signal levels in normal operating range

5. TEMP

This LED lights up if the limiter has been activated and the power amplifier is being operated at the clip level. If the LED flashes briefly, this is not a cause for concern. If this LED is lit permanently, the volume should be reduced to avoid overload damages to the connected loudspeaker systems.

6. VHF

VHF-Very High Frequency protection active (output muted) (Yellow Constant)

7. CPL LED

CPL-(Orange constant with output muted): Low impedance/Short Circuit Detection Fault

8. POWER SWITCH

Turn the unit power on or off



Rear panel features introduction

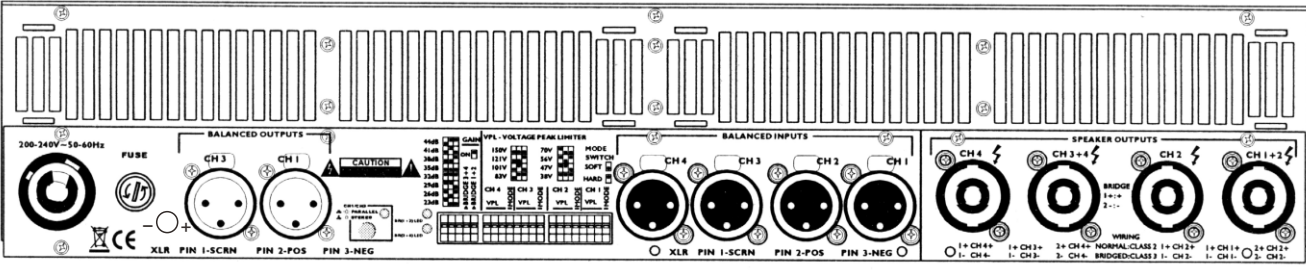
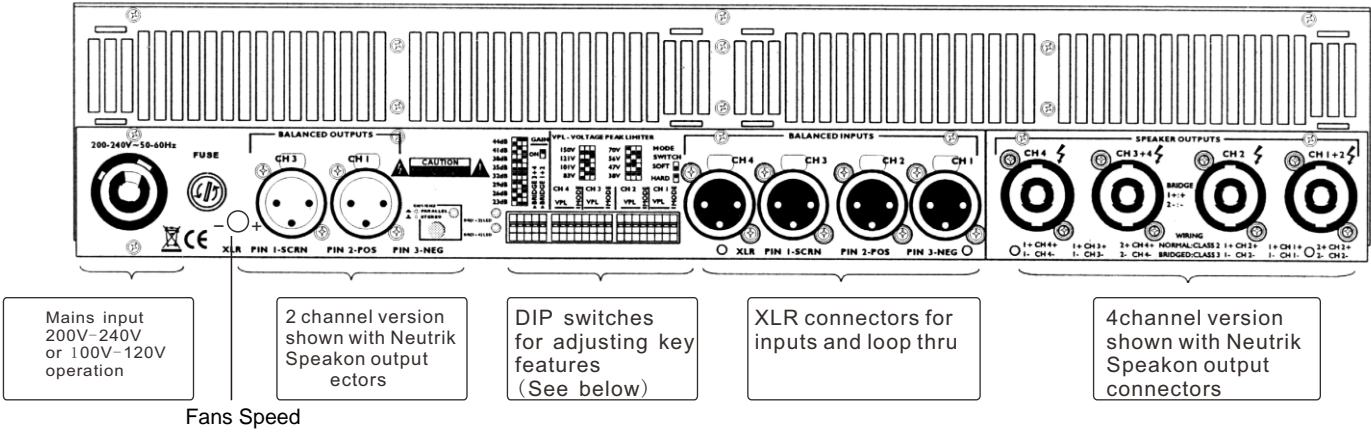

Rear view of 4-channel model fitted with Speakon Connectors



Four-channel model shown. Two-channel versions have VPL and Bridge Mode switches for channel 1 and 2 only. All models have different VPL values. Functions are otherwise identical.

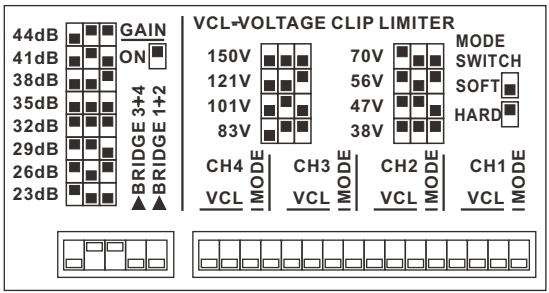

6.2.2 The DIP switch features

The following features may be adjusted using the DIP switches on the rear-panel of the amplifier. Gain-Globally set for all channels, from +23 dB to +44 dB in 3 dB steps.

Bridge 1+2 and 3+4 Switches the channel pairs into bridge mode operation an automatic -6 dB gain compensation is applied.



Rear panel features introduction

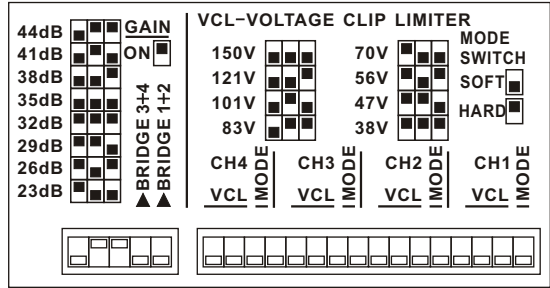

VCL-Voltage Clip Limiter adjustment is provided for eight discrete levels for each channel. Select the setting most appropriate for connected speakers.

Mode-Select VCL mode to either Hard or Soft operation. For channels driving sub-woofers and low-frequency drivers, it is recommended to use the Hard setting for optimal operation. For mid- and high-frequency drivers, always select Soft.

Output Connectors

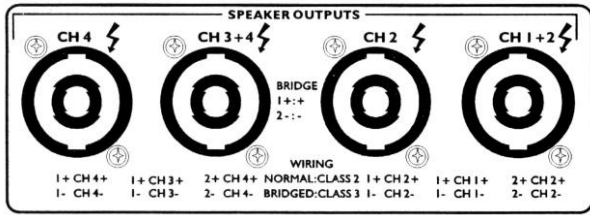

Speakon outputs-4-channel models

Input Connectors

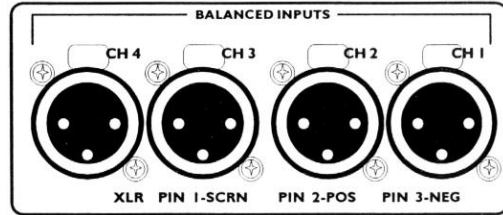

Audio inputs-4-channel models

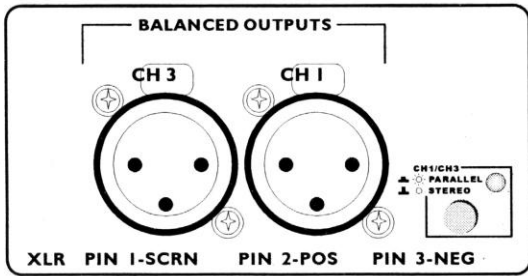

Speakon outputs PARALLEL or STEREO models

Speakon outputs PARALLEL or STEREO models: In stereo models, the signal input into channel 1 can be output from channel 1 only, similarly, the signal channel 3 is the same. In parallel models, the signal input into channel 1 or channel 3 can be output from channel 1 and channel 3.

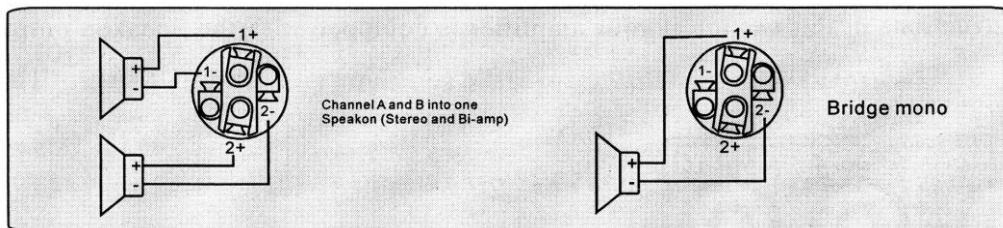

Four-channel amplifiers Additional connectors are provided for channel 3 and channel 4. Channel 3 functions as channel 1 above, and channel 4 as channel 2 above.



Audio input and output connections

BALANCED INPUT CONNECTIONS

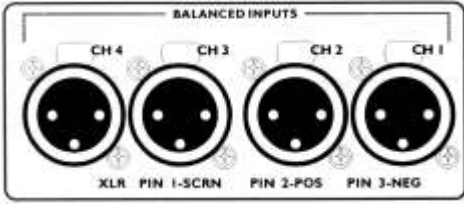

Audio input-4-channel models

The XLR input connectors are electronically balanced, and wired according to the IEC 268 standard (pin 2= hot). XLR input connectors should be wired follows:

- Pin 1 Ground/Shield
- Pin 2 Hot (+)
- Pin 3 Cold (-)

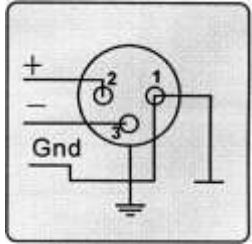

When linking the same source signal to several input channels, be aware that there is a limit to the number of channels an output source can "drive". A typical output source (e.g. a DSP crossover unit) can drive up to four amplifier channels before external line-drivers might be required to buffer the signal.

Unbalanced Input connections

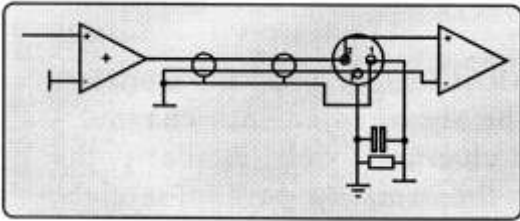

To connect an input to an unbalanced source, it is possible to connect pins 1 and 3 in the XLR plug at the amplifier end of the cable. However, a better method is to connect pin 3 to the shield at the source end of the cable, as this usually results in better hum and noise rejection. Balanced input connections are recommended whenever possible

Speakon Output connections

Refer to the instructions in this section if your amplifier is equipped with the Speakon output connectors

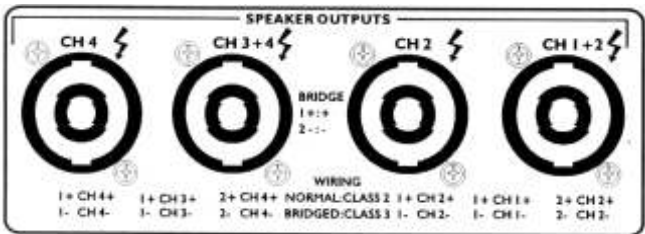

Speakon outputs-4-channel models



Output Mode

Stereo Mode

Before setting the mode, please turn off the amplifier and slide the mode select switch to below (Picture 1). In this mode, Channel 1 and Channel 2 operate independently (Just traditional stereo amplifier). The signal input into channel 1 can be output from channel 1 only, similarly, the signal input into channel 2 can be output from channel 2 only. The many channels, one by one in order type pushes.

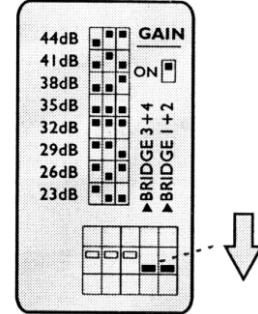

(Picture 1)

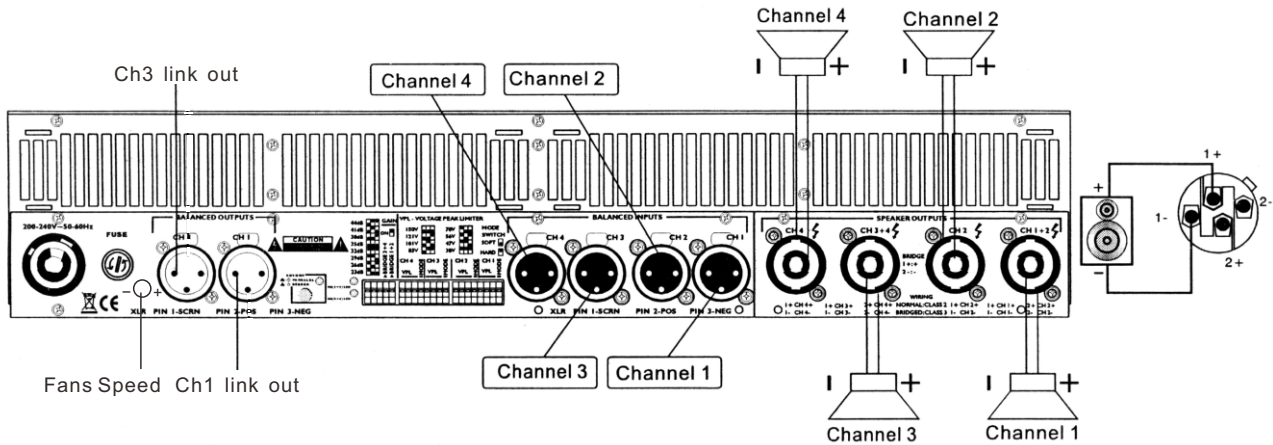

Bridge Mode

Before setting the mode, please turn off the amplifier and slide the mode select switch to above (Picture 2), channel 1 and channel 2 are bridged, channel 3 and channel 4 are bridged. At time, the signal input into channel 1 and channel 3 will be output from the bridge end. On other hand, the output level control of channel 2 and channel 4 should be turn down to smallest. Only the volume control of channel 1 and channel 3 are used to control the volume of whole system.

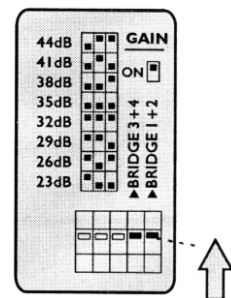

(Picture 2)

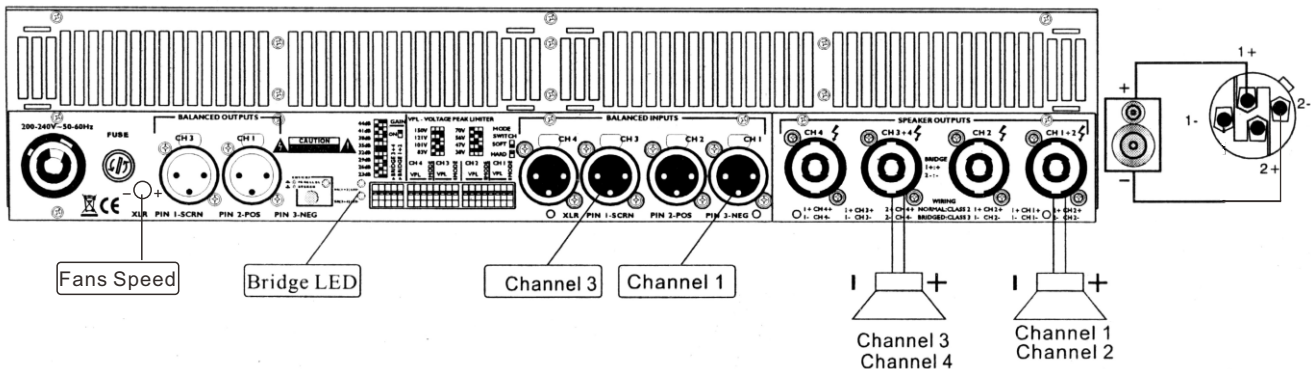



Professional Power Amplifier Specifications

MODEL	HT-10Q
Output Power	
8R Stereo Power	4×1300W
4R Stereo Power	4×2200W
2R Stereo Power	4×2500W
8R Bridged Monon Power	2×4400W
4R Bridged Monon Power	2×5000W

FREQUENCY RESPONSE	20Hz-25kHz ±0.5dB
THD+N(Rated power,4ohm/1KHz)%	0.10%
Signal Noise Ration(dB)	110dB
Input Impedance	20Kohm Balanced / 10kohm Unbalanced
Ampitier gain selectable (All channels)-rell-panel switches	23,26,29,32,35,38,41,44dB
Output Connectors	Speakon Connectors(NEUTRIK)
Power Requirement	100-120V-50-60Hz or 200-240V-50-60Hz

Dimension	
Airframe	483×377×88mm
Weight	
Weight(net)	13Kg

