

GENERAL FEATURES

- Environmentally friendly
- Able to operate at 60°C
- Integrated design to ensure the best uniformity and reliability
- Long life and high stability under high temp. environment (no air-con needed)
- Use super-C additives: Deep discharge recovery capability

APPLICATIONS

- Solar & Wind energy system
- BTS Stations
- UPS system
- Telecom systems
- Wheel chair & Golf Car
- Marine Equipment
- Railway Systems



DIMENSIONS & WEIGHT

Length(mm)	229±1
Width(mm)	138±1
Height(mm)	208±1
Total Height(mm)	212±1
Weight(kg)	16.1±3%

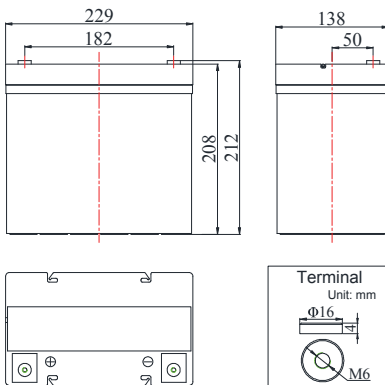

COMPLIED STANDARDS

IEC 60896-21/22	JIS C8704
YD/T1360	BS6290 part4
GB/T 19638	UL 1989

TECHNICAL SPECIFICATIONS



Nominal Voltage		12V(6 cells per unit)
Design Floating Life @25°C		15 Years
Nominal Capacity @25°C(20 hour rate@2.75A,10.50V)		55Ah
Capacity @25°C	10 hour rate (5.17A,10.8V)	51.7Ah
	5 hour rate (8.7A,10.5V)	43.5Ah
	1 hour rate (30.6A,9.6V)	30.6Ah
Internal Resistance	Full Charged Battery@25°C	≤10.0mΩ
Ambient Temperature	Discharge	-30°C~60°C
	Charge	-30°C~60°C
	Storage	-30°C~60°C
Max.Discharge Current@25°C		550A(5s)
Capacity affected by Temperature (10 hr Capacity)	40°C	108%
	25°C	100%
	0°C	90%
	-15°C	70%
Self-Discharge@25°C per Month		3%
Charge (Constant Voltage) @25°C	Standby Use	Initial Charging Current Less than 12.4A Voltage 13.6-13.8V
	Cycle Use	Initial Charging Current Less than 12.4A Voltage 14.4-14.9V

BATTERY DISCHARGE TABLE

Discharge Constant Current per Cell (Amperes at 25°C)

F.V/Time	15min	30min	45min	1h	2h	3h	5h	8h	10h	20h	100h
1.60V	70.8	45.2	33.2	30.6	19.4	13.6	9.2	6.1	5.45	2.92	0.66
1.67V	69.5	44.4	32.6	30.0	19.0	13.4	9.1	6.0	5.34	2.86	0.65
1.70V	68.2	43.6	32.0	29.4	18.7	13.1	8.9	5.9	5.23	2.81	0.63
1.75V	66.9	42.7	31.4	28.9	18.3	12.9	8.7	5.8	5.17	2.75	0.62
1.80V	64.4	41.1	30.2	27.8	17.6	12.4	8.4	5.6	5.01	2.72	0.61

Discharge Constant Power per Cell (Watts at 25°C)

F.V/Time	15min	30min	45min	1h	2h	3h	5h	8h	10h	20h	100h
1.60V	136.2	87.0	64.0	58.7	37.3	26.2	17.8	11.7	10.5	5.7	1.27
1.67V	133.8	85.4	62.8	57.6	36.6	25.7	17.5	11.6	10.3	5.6	1.24
1.70V	131.3	83.8	61.6	56.5	36.0	25.2	17.2	11.3	10.1	5.5	1.22
1.75V	128.8	82.2	60.4	55.5	35.3	24.8	16.8	11.1	9.9	5.4	1.20
1.80V	123.9	79.1	58.1	53.4	33.9	23.8	16.2	10.7	9.5	5.3	1.18

Note The above data are average values, and can be obtained within 3 charge/discharge cycles. These are not minimum values. Cell and battery designs/specifications are subject to modification without notice. Contact **CBB** for the latest information.

PERFORMANCE CHARACTERISTICS

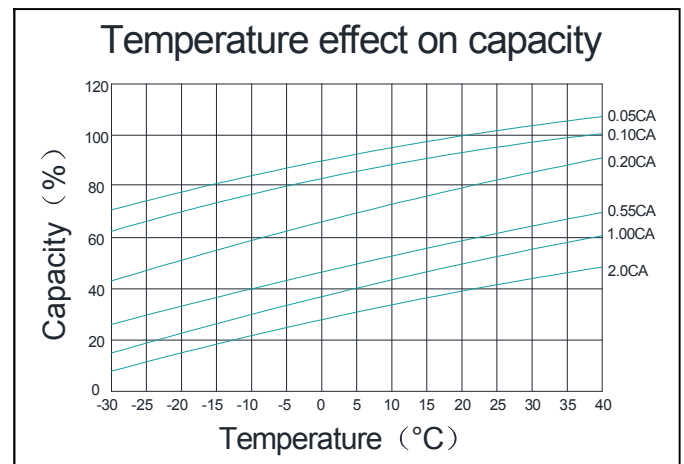
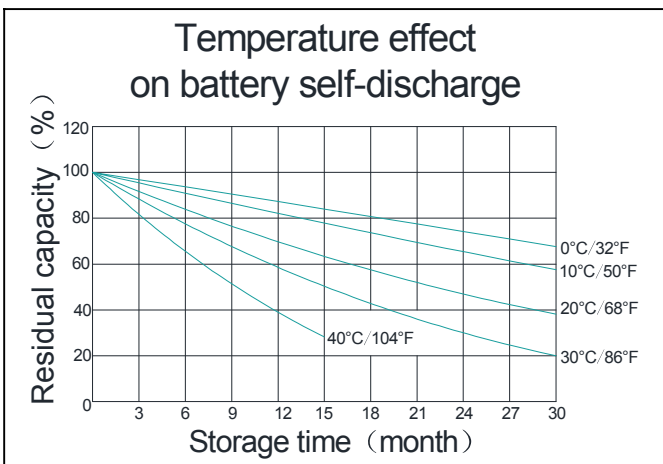
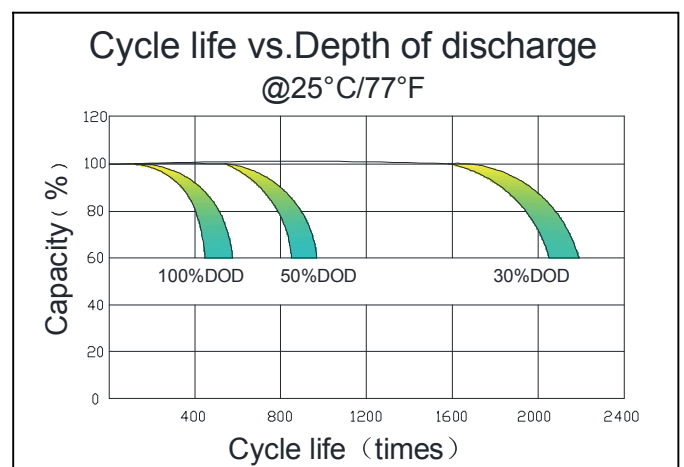
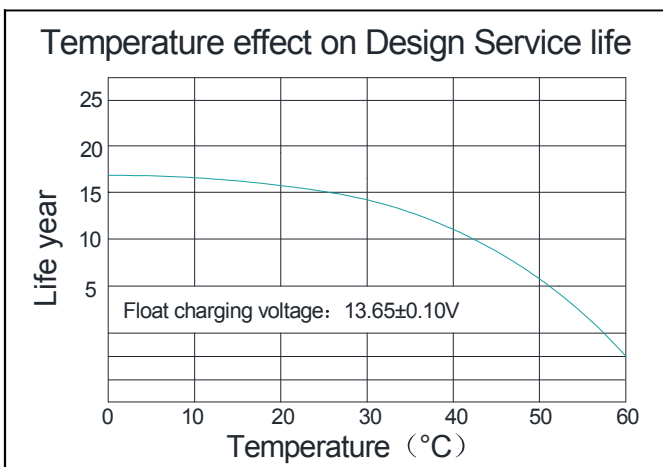
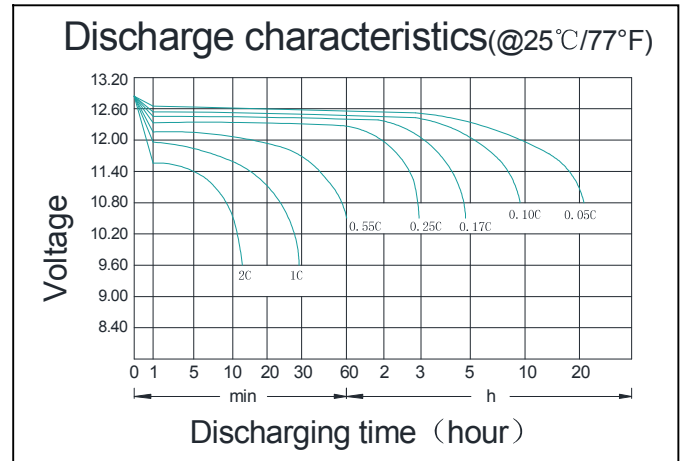
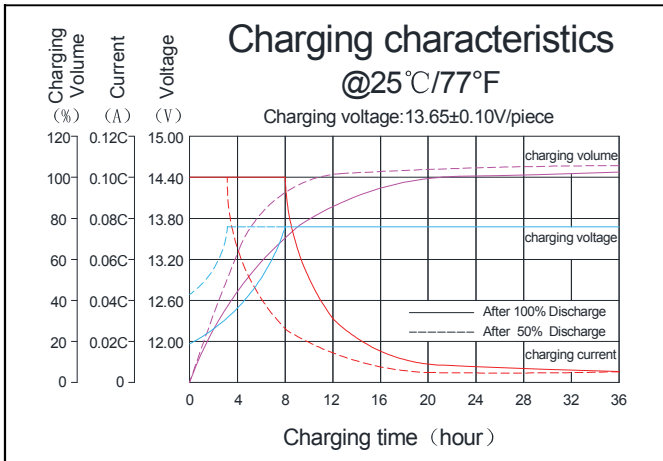

BATTERY CONSTRUCTION

Component	Positive plate	Negative plate	Container & Cover	Safety valve	Terminal	Separator	Electrolyte	Pillar seal
Features	Thick high Sn low Ca grid with special paste	Balanced Pb-Ca grid for improved recombination efficiency	ABS (UL94-V0 optional)	Flame Si-Rubbeand aging resistanacer	Female Copper Insert M6(torque:4 ~6N.m)	Advanced AGM separator for high pressure cell design	Dilute high purity sulphuric acid with fumed Silica gel	Two layers epoxy resin seal

CBB Battery Technology Co.,Ltd.

RM504,55 Hanxing Road,Zhongcun, Panyu,Guangzhou 511495 China
 Tel: +86-020-84888946 Fax: +86-020-62824569

Koyama®

www.cbb-battery.com