

## GENERAL FEATURES

- Environmentally friendly
- Able to operate at 60°C
- Integrated design to ensure the best uniformity and reliability
- Long life and high stability under high temp. environment (no air-con needed)
- Use super-C additives: Deep discharge recovery capability

## APPLICATIONS

- Solar & Wind energy system
- BTS Stations
- UPS system
- Telecom systems
- Wheel chair & Golf Car
- Marine Equipment
- Railway Systems



## DIMENSIONS & WEIGHT

Length(mm)	295±1
Width(mm)	178±1
Height(mm)	346±1
Total Height(mm)	350±1
Weight(kg)	46.2±3%

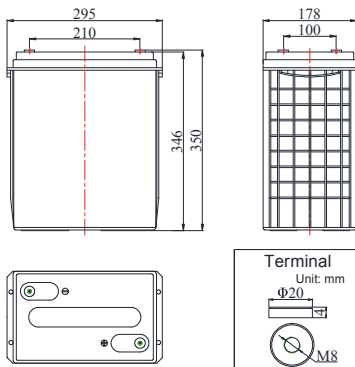

## COMPLIED STANDARDS

IEC 60896-21/22	JIS C8704
YD/T1360	BS6290 part4
GB/T 19638	UL 1989

## TECHNICAL SPECIFICATIONS



Nominal Voltage		6V(3 cells per unit)
Design Floating Life @25°C		15 Years
Nominal Capacity @25°C(20 hour rate@15.50A,5.25V )		310Ah
Capacity @25°C	10 hour rate (28.21A,5.40V)	282.1Ah
	5 hour rate (49.30A,5.25V)	246.5Ah
	1 hour rate (172.4A,4.80V)	172.4Ah
Internal Resistance	Full Charged Battery@25°C	≤2.6mΩ
Ambient Temperature	Discharge	-30°C~60°C
	Charge	-30°C~60°C
	Storage	-30°C~60°C
Max.Discharge Current@25°C		2000A(5s)
Capacity affected by Temperature (10 hr Capacity )	40°C	108%
	25°C	100%
	0°C	90%
	-15°C	70%
Self-Discharge@25°C per Month		3%
Charge (Constant Voltage) @25°C	Standby Use	Initial Charging Current Less than 55.8A Voltage 6.8-6.9V
	Cycle Use	Initial Charging Current Less than 55.8A Voltage 7.2-7.45V

## BATTERY DISCHARGE TABLE

### Discharge Constant Current per Cell (Amperes at 25°C)

F.V/Time	15min	30min	45min	1h	2h	3h	5h	8h	10h	20h	100h
1.60V	399.0	254.8	187.2	172.4	109.4	76.9	52.1	34.4	30.69	16.43	3.72
1.67V	391.8	250.2	183.8	169.0	107.3	75.3	51.2	33.8	30.07	16.12	3.66
1.70V	384.4	245.5	180.4	165.9	105.4	74.1	50.2	33.2	29.45	15.81	3.57
1.75V	377.3	240.9	177.0	162.8	103.2	72.5	49.3	32.6	29.14	15.50	3.50
1.80V	362.7	231.6	170.2	156.6	99.2	69.8	47.4	31.3	28.21	15.35	3.44

### Discharge Constant Power per Cell (Watts at 25°C)

F.V/Time	15min	30min	45min	1h	2h	3h	5h	8h	10h	20h	100h
1.60V	421.1	268.9	197.7	181.4	115.3	80.9	55.1	36.2	32.5	17.6	3.93
1.67V	413.4	264.0	194.0	178.2	113.2	79.6	54.1	35.7	31.8	17.2	3.84
1.70V	405.8	259.1	190.4	174.8	111.2	78.0	53.0	35.0	31.3	17.1	3.77
1.75V	398.1	254.2	186.8	171.5	109.0	76.5	52.0	34.3	30.6	16.8	3.71
1.80V	382.8	244.5	179.7	164.9	104.9	73.6	50.2	33.0	29.4	16.3	3.64

**Note** The above data are average values, and can be obtained within 3 charge/discharge cycles. These are not minimum values. Cell and battery designs/specifications are subject to modification without notice. Contact **CBB** for the latest information.

## PERFORMANCE CHARACTERISTICS

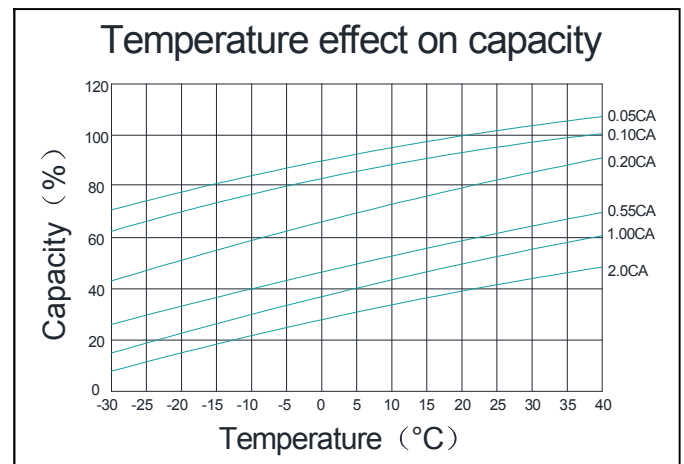
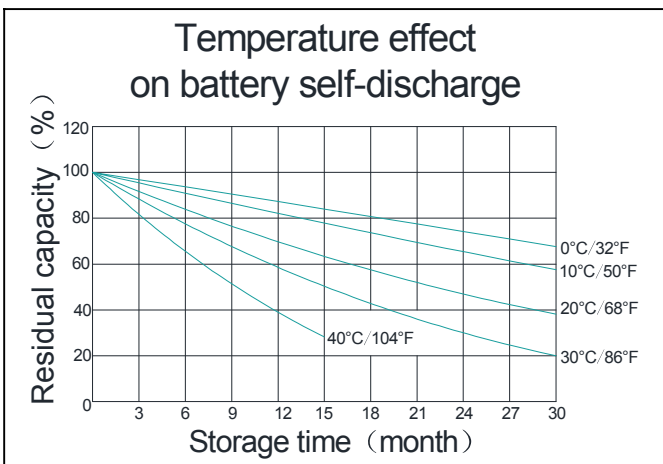
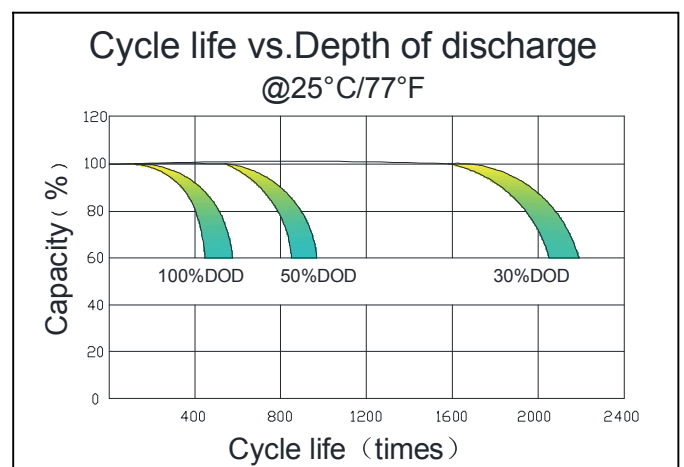
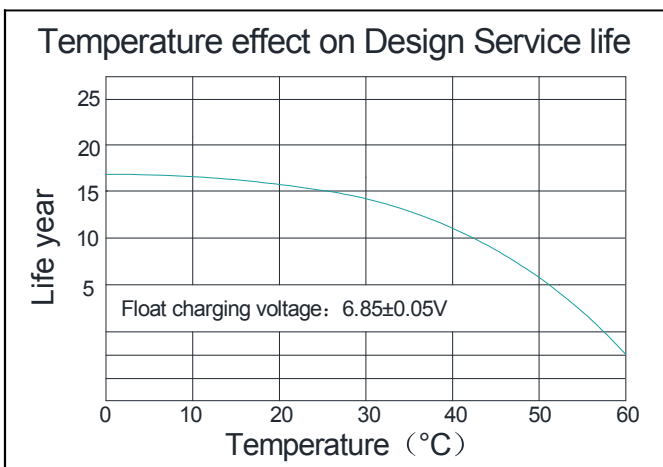
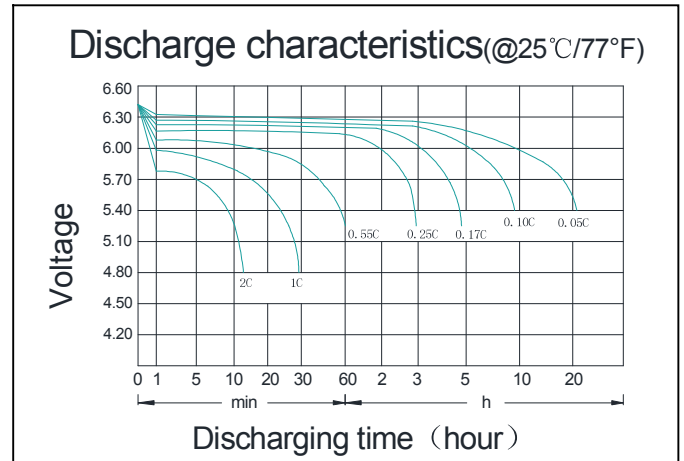
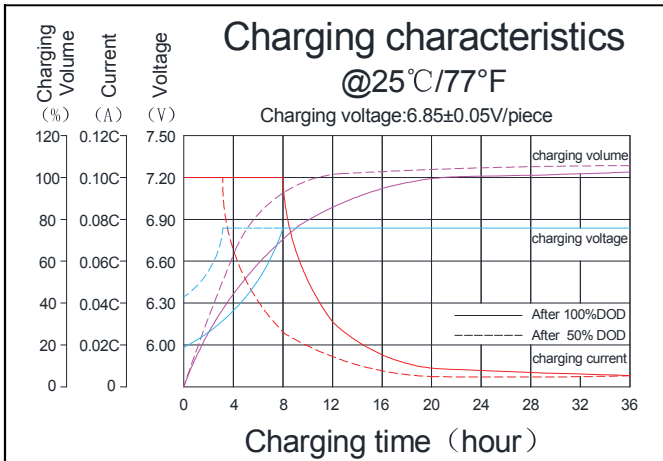

## BATTERY CONSTRUCTION

Component	Positive plate	Negative plate	Container & Cover	Safety valve	Terminal	Separator	Electrolyte	Pillar seal
Features	Thick high Sn low Ca grid with special paste	Balanced Pb-Ca grid for improved recombination efficiency	ABS (UL94-V0 optional)	Flame Si-Rubbeand aging resistanacer	Female Copper Insert M8(torque:7~9N.m)	Advanced AGM separator for high pressure cell design	Dilute high purity sulphuric acid with fumed Silica gel	Two layers epoxy resin seal

**CBB Battery Technology Co.,Ltd.**

RM504,55 Hanxing Zhong Road,Zhongcun, Panyu,Guangzhou 511495 China  
Tel: +86-020-84888946 Fax: +86-020-62824569

**Koyama®**

www.cbb-battery.com