

Wiring Diagram

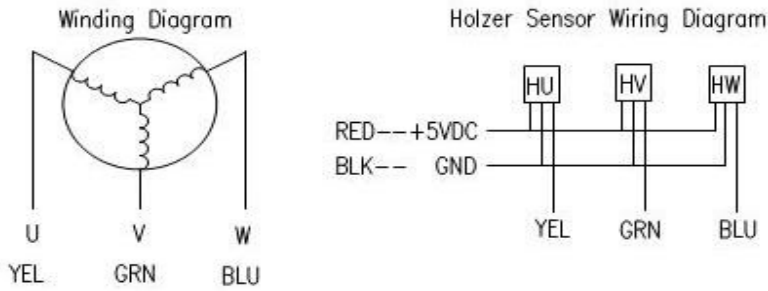

Appearance Size & Motor Installation

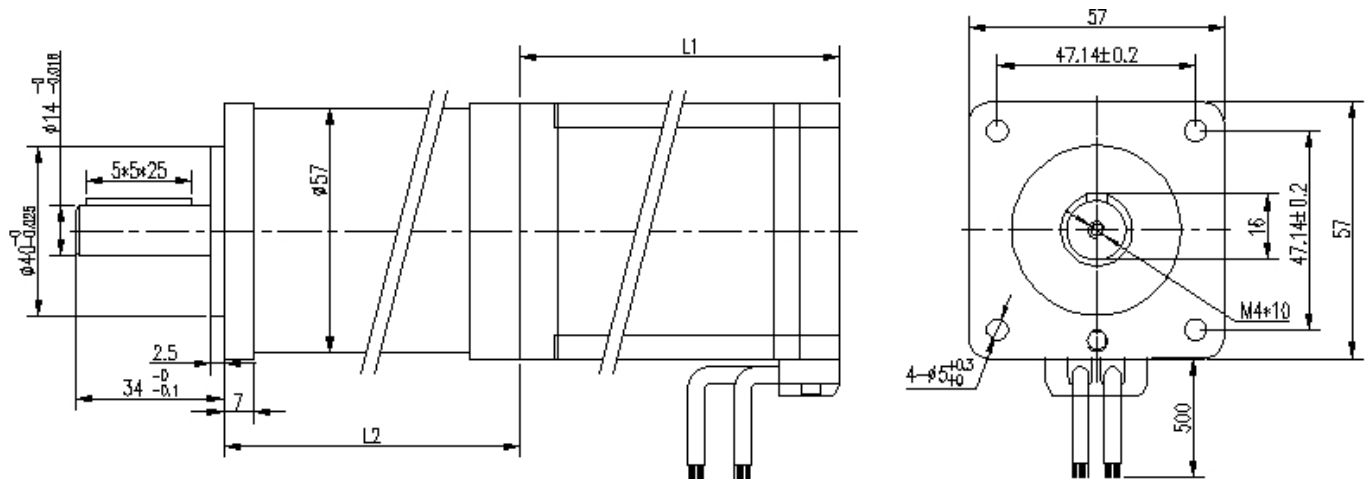

Motor Electrical Specification

Motor Model	DG575-60W	DG575-120W	DG575-180W
Rated Voltage(VDC)	48	48	48
Rated Speed(Rpm)	3000	3000	3000
Rated Torque(N.m)	0.2	0.4	0.6
Rated Power(W)	60	120	180
L1 Length(mm)	58	78	98

Gearbox Electrical Specification

Reducer Series	1	2
Transmission efficiency	95%	90%
Max radial load	80N	80N
Max axial load	30N	30N
Transmission torque	40N.m	60N.m
Reduction Ratio	5,10	15,20,,25,30,40,50
L2 Length(mm)	55	71

* Note: We can manufacture products according to customer's requirements.
Optional accessory is the encoder and brake to match this product.

* Contact sales@ichmo.com.