



Ref. Certif. No.

JPTUV-049023

IEC SYSTEM FOR MUTUAL RECOGNITION OF TEST CERTIFICATES FOR ELECTRICAL EQUIPMENT (IECEE) CB SCHEME

SYSTEME CEI D'ACCEPTATION MUTUELLE DE CERTIFICATS D'ESSAIS DES EQUIPEMENTS ELECTRIQUES (IECEE) METHODE OC

CB TEST CERTIFICATE CERTIFICAT D'ESSAI OC

Product
Produit

Switching Power Supply

Name and address of the applicant
Nom et adresse du demandeur

Fuyuan Electronic Co., Ltd.
Xiewu Village, Hengshan
Shipai Town, Dongguan, Guangdong 523335, P.R. China

Name and address of the manufacturer
Nom et adresse du fabricant

Fuyuan Electronic Co., Ltd.
Xiewu Village, Hengshan
Shipai Town, Dongguan, Guangdong 523335, P.R. China

Name and address of the factory
Nom et adresse de l'usine

Fuyuan Electronic Co., Ltd.
Xiewu Village, Hengshan
Shipai Town, Dongguan, Guangdong 523335, P.R. China

Rating and principal characteristics
Valeurs nominales et caractéristiques principales

Input : AC 100-240V, 50/60Hz, 2.5A Max., Class II
Output: refer to test report

Trade mark (if any)
Marque de fabrique (si elle existe)

Fuyuang

Model/type Ref.
Ref. de type

FYxxxyyyy
(xxx, yyyy = refer to test report)

Additional information (if necessary)
Information complémentaire (si nécessaire)

For model differences, refer to the test report

A sample of the product was tested and found to be in conformity with
Un échantillon de ce produit a été essayé et a été considéré conforme à la

IEC 60950-1:2005+A1
National differences see test report

As shown in the Test Report Ref. No. which forms part of this Certificate
Comme indiqué dans le Rapport d'essais numéro de référence qui constitue une partie de ce Certificat

17029847 001

This CB Test Certificate is issued by the National Certification Body
Ce Certificat d'essai OC est établi par l'Organisme National de Certification



TÜVRheinland®

TUV Rheinland Japan Ltd
Global Technology Assessment Center
4-25-2 Kita-Yamate, Tsuzuki-ku
Yokohama 224-0021 Japan
Phone : +81 45 914-3888
Fax : +81 45 914-3354
Mail: info@jpn.tuv.com
Web: www.tuv.com

Date: 21.01.2013

Signature:



Dipl.-Ing. Univ. S. O. Steinkamp



Test Report issued under the responsibility of:

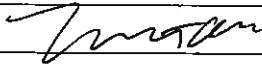

TEST REPORT	
IEC 60950-1	
Information technology equipment – Safety – Part 1: General requirements	
Report Number	17029847 001
Date of issue	Jan.14, 2013
Total number of pages	128
CB Testing Laboratory	TÜV Rheinland (Shenzhen) Co., Ltd.
Address	3&4 F, Cybio Technology Building No. 1, Langshan No. 2 Road South, 5th Industrial Area, High-Tech Industry Park North, Nanshan District, 518057 Shenzhen China.
Applicant's name	Fuyuan Electronic Co., Ltd.
Address	Xiewu village, Hengshan, Shipai town, Dongguan, Guangdong, China
Manufacturer's name	Same as applicant
Address	Same as applicant
Test specification:	
Standard	IEC 60950-1:2005 (Second Edition) + Am 1:2009
Test procedure	CB
Non-standard test method	N/A
Test Report Form No.	IEC60950_1C
Test Report Form(s) Originator	SGS Fimko Ltd
Master TRF	Dated 2012-08
Copyright © 2012 Worldwide System for Conformity Testing and Certification of Electrotechnical Equipment and Components (IECEE), Geneva, Switzerland. All rights reserved.	
This publication may be reproduced in whole or in part for non-commercial purposes as long as the IECEE is acknowledged as copyright owner and source of the material. IECEE takes no responsibility for and will not assume liability for damages resulting from the reader's interpretation of the reproduced material due to its placement and context.	
If this Test Report Form is used by non-IECEE members, the IECEE/IEC logo and the reference to the CB Scheme procedure shall be removed.	
This report is not valid as a CB Test Report unless signed by an approved CB Testing Laboratory and appended to a CB Test Certificate issued by an NCB in accordance with IECEE 02.	

Test item description :		Switching Power Supply	
Trade Mark :			
Manufacturer :		Same as applicant	
Model/Type reference :		FYxxxxyyy (for xxx and yyyy refer to page 6)	
Ratings :		Input: 100-240V~, 50/60Hz, Max 2.5A Output: see table A on page 6-16	
Testing procedure and testing location:			
<input checked="" type="checkbox"/>	CB Testing Laboratory:	TÜV Rheinland (Shenzhen) Co., Ltd.	
Testing location/ address..... :		3&4 F, Cybio Technology Building No. 1, Langshan No. 2 Road South, 5 th Industrial Area, High-Tech Industry Park North, Nanshan District, 518057 Shenzhen China.	
<input type="checkbox"/>	Associated CB Laboratory:	N/A	
Testing location/ address..... :		N/A	
Tested by (name + signature)..... :		Lew Liu	
Approved by (name + signature)..... :		Tristan Deng	
<input type="checkbox"/>	Testing procedure: TMP	N/A	
Testing location/ address..... :		N/A	
Tested by (name + signature)..... :			
Approved by (name + signature)..... :			
<input type="checkbox"/>	Testing procedure: WMT	N/A	
Testing location/ address..... :		N/A	
Tested by (name + signature)..... :			
Witnessed by (name + signature)..... :			
Approved by (name + signature)..... :			
<input type="checkbox"/>	Testing procedure: SMT	N/A	
Testing location/ address..... :		N/A	
Tested by (name + signature)..... :			
Approved by (name + signature)..... :			
Supervised by (name + signature)..... :			
<input type="checkbox"/>	Testing procedure: RMT	N/A	
Testing location/ address..... :		N/A	
Tested by (name + signature)..... :			
Approved by (name + signature)..... :			
Supervised by (name + signature)..... :			

List of Attachments (including a total number of pages in each attachment):

- Attachment 1: Photo documentation (7 pages)

Summary of testing:

Tests performed (name of test and test clause):

1. The tests of Switching Power Supply FYxxxxyyy series were carried out under the most unfavourable combination within the manufacturer's operating specifications of the following parameters:
 - supply voltage, which ranged from 100Va.c. to 240Va.c.
 - operating temperature, Max. ambient temperature 25°C declared by the client
 - operating mode: continuous
 - operating load: the highest normal load, also see table A on page 6-16.
2. Following tests performed during evaluation

Clause(s)	Test(s)
1.6.2	Input Current Test
1.7.11	Durability of Marking Test
2.1.1.1	Access to energized parts
2.1.1.5	Energy Hazard in Operator Access Area
2.2.2	SELV limits for Normal Conditions
2.2.3	SELV limits for Abnormal Conditions
2.4.2	Limit Current Circuit
2.5	Limited Power Sources
2.9.2	Humidity Conditioning
2.10.2	Working Voltage over Insulation
2.10.3 & 2.10.4	Clearance and creepage distance measurements
4.2.4	Steady force test
4.2.6	Drop Test
4.2.7	Stress relief test
4.3.6	Torque Test
4.5.2	Maximum Temperature Test
4.5.5	Ball Pressure Test
5.1.6	Touch Current and PE current
5.2	Electric Strength Test
5.3	Fault Condition Test

2. Test of models FY1267500, FY2405000, FY4802500 and FY5802000 representing all models, test for models FY0307500 and FY1207500 for reference only.
3. All test data were taken from CB report 12014620 001.

Testing location:

All tests as described in Test Case and Measurement Sections were performed at the laboratory described on page 2

Summary of compliance with National Differences

EU Group Differences, EU Special National Conditions, AR, AT, AU*, BE, CA, CH, CN, DE, DK, FI, FR, GB, GR, HU, IL, IN, IT, JP#, KE, KR, NL, NO, PL, SE, SI, SK, US

AR=Argentina, AT=Austria, AU=Australia, BE=Belgium, CA=Canada, CH=Switzerland, CN=China, DE=Germany, DK=Denmark, FI=Finland, FR=France, GB=United Kingdom, GR=Greece, HU=Hungary, IL=Israel, IN=India, IT=Italy, JP=Japan, KR=Korea, KE=Kenya, NL=The Netherlands, NO=Norway, PL=Poland, SE=Sweden, SI=Slovenia, SK=Slovakia, US=United States of America.

For National Differences see end of this test report.

*National differences to IEC 60950-1:2005 evaluated.

National differences to IEC 60950-1:2001 evaluated

The product fulfils the requirements of EN 60950-1:2006+A11:2009+A1:2010+A12:2011.

Copy of marking plate

The use of certification marks on a product must be authorized by the respective NCBs that own these marks.

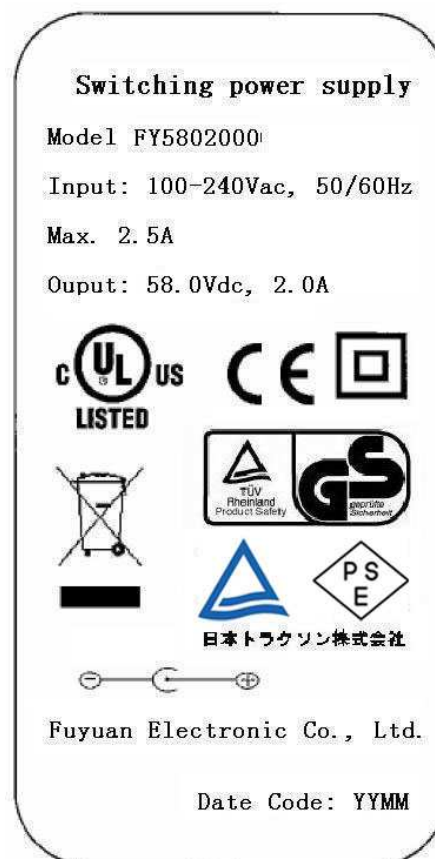

Test item particulars	
Equipment mobility	<input checked="" type="checkbox"/> movable <input type="checkbox"/> hand-held <input type="checkbox"/> transportable <input type="checkbox"/> stationary <input type="checkbox"/> for building-in <input type="checkbox"/> direct plug-in
Connection to the mains.....	<input checked="" type="checkbox"/> pluggable equipment <input checked="" type="checkbox"/> type A <input type="checkbox"/> type B <input type="checkbox"/> permanent connection <input type="checkbox"/> detachable power supply cord <input type="checkbox"/> non-detachable power supply cord <input type="checkbox"/> not directly connected to the mains
Operating condition	<input checked="" type="checkbox"/> continuous <input type="checkbox"/> rated operating / resting time:
Access location	<input checked="" type="checkbox"/> operator accessible <input type="checkbox"/> restricted access location
Over voltage category (OVC)	<input type="checkbox"/> OVC I <input checked="" type="checkbox"/> OVC II <input type="checkbox"/> OVC III <input type="checkbox"/> OVC IV <input type="checkbox"/> other:
Mains supply tolerance (%) or absolute mains supply values	+6% for upper limit, -10% for lower limit.
Tested for IT power systems	<input type="checkbox"/> Yes <input checked="" type="checkbox"/> No
IT testing, phase-phase voltage (V)	N/A
Class of equipment	<input type="checkbox"/> Class I <input checked="" type="checkbox"/> Class II <input type="checkbox"/> Class III <input type="checkbox"/> Not classified
Considered current rating of protective device as part of the building installation (A)	16A
Pollution degree (PD)	<input type="checkbox"/> PD 1 <input checked="" type="checkbox"/> PD 2 <input type="checkbox"/> PD 3
IP protection class	IP20
Altitude during operation (m)	Up to 2000
Altitude of test laboratory (m)	below 2000
Mass of equipment (kg)	< 0.32
Possible test case verdicts:	
- test case does not apply to the test object.....	N/A
- test object does meet the requirement.....	P (Pass)
- test object does not meet the requirement.....	F (Fail)
Testing	
Date of receipt of test item	Dec. 06, 2012
Date(s) of performance of tests	Aug. 2006-Sep. 2006
General remarks:	
The test results presented in this report relate only to the object tested. This report shall not be reproduced, except in full, without the written approval of the Issuing testing laboratory. "(see Enclosure #)" refers to additional information appended to the report. "(see appended table)" refers to a table appended to the report.	
Throughout this report a point is used as the decimal separator.	

Manufacturer's Declaration per sub-clause 6.2.5 of IEC 60950-1:							
The application for obtaining a CB Test Certificate includes more than one factory location and a declaration from the Manufacturer stating that the sample(s) submitted for evaluation is (are) representative of the products from each factory has been provided				<input type="checkbox"/> Yes <input checked="" type="checkbox"/> Not applicable			
When differences exist; they shall be identified in the General product information section.							
Name and address of factory (ies)..... : Same as manufacturer.							
General product information:							
The EUTs are desk-top type switching power supply intended to use for information technology equipments.							
Top enclosure and bottom enclosure were secured by ultrasonic.							
All models have the similar construction. Differences between models see table A.							
Definition of variables:							
Variable:	Range of variable:			Content:			
xxx	030 to 580			Three digits, indicates 10 times of output voltage in volt			
yyyy	0300 to 7500			Four digits, indicates the output current in mA.			
Table A (Model list and components difference)							
Type Designation	Input	Output			Components Difference		
	VAC	W	V	mA	Sec.winding	D8 D9	C15 C16
FY0300300	100-240	0.9	3	300	2X0.9MM 3T	20A 45V	1000uF 10V
FY0300400	100-240	1.2	3	400			
FY0300500	100-240	1.5	3	500			
FY0301000	100-240	3	3	1000			
FY0301500	100-240	4.5	3	1500			
FY0302000	100-240	6	3	2000			
FY0303000	100-240	9	3	3000			
FY0304000	100-240	12	3	4000			
FY0305000	100-240	15	3	5000			
FY0306000	100-240	18	3	6000			
FY0307000	100-240	21	3	7000			
FY0307500	100-240	22.5	3	7500			
FY0420300	100-240	1.26	4.2	300			
FY0420400	100-240	1.68	4.2	400			
FY0420500	100-240	2.1	4.2	500			
FY0420600	100-240	2.52	4.2	600			
FY0420700	100-240	2.94	4.2	700			
FY0420800	100-240	3.36	4.2	800			
FY0420900	100-240	3.78	4.2	900			
FY0421000	100-240	4.2	4.2	1000			
FY0421500	100-240	6.3	4.2	1500			
FY0422000	100-240	8.4	4.2	2000			

FY0423000	100-240	12.6	4.2	3000			
FY0424000	100-240	16.8	4.2	4000			
FY0425000	100-240	21	4.2	5000			
FY0426000	100-240	25.2	4.2	6000			
FY0427000	100-240	29.4	4.2	7000			
FY0427500	100-240	31.5	4.2	7500			
FY0500300	100-240	1.5	5	300	2X0.9MM 3T	20A 45V	1000uF 10V
FY0500400	100-240	2	5	400			
FY0500500	100-240	2.5	5	500			
FY0500600	100-240	3	5	600			
FY0500700	100-240	3.5	5	700			
FY0500800	100-240	4	5	800			
FY0500900	100-240	4.5	5	900			
FY0501000	100-240	5	5	1000			
FY0501500	100-240	7.5	5	1500			
FY0502000	100-240	10	5	2000			
FY0503000	100-240	15	5	3000			
FY0504000	100-240	20	5	4000			
FY0505000	100-240	25	5	5000			
FY0506000	100-240	30	5	6000			
FY0507000	100-240	35	5	7000			
FY0507500	100-240	37.5	5	7500			
FY0600300	100-240	1.8	6	300	2X0.9MM 3T	20A 45V	1000uF 10V
FY0600400	100-240	2.4	6	400			
FY0600500	100-240	3	6	500			
FY0600600	100-240	3.6	6	600			
FY0600700	100-240	4.2	6	700			
FY0600800	100-240	4.8	6	800			
FY0600900	100-240	5.4	6	900			
FY0601000	100-240	6	6	1000			
FY0601500	100-240	9	6	1500			
FY0602000	100-240	12	6	2000			
FY0603000	100-240	18	6	3000			
FY0604000	100-240	24	6	4000			
FY0605000	100-240	30	6	5000			
FY0606000	100-240	36	6	6000			
FY0607000	100-240	42	6	7000			
FY0607500	100-240	45	6	7500			
FY0750300	100-240	2.25	7.5	300	2X0.9MM 3T	20A 45V	1000uF 10V
FY0750400	100-240	3	7.5	400			
FY0750500	100-240	3.75	7.5	500			
FY0750600	100-240	4.5	7.5	600			
FY0750700	100-240	5.25	7.5	700			
FY0750800	100-240	6	7.5	800			
FY0750900	100-240	6.75	7.5	900			

FY0751000	100-240	7.5	7.5	1000			
FY0751500	100-240	11.25	7.5	1500			
FY0752000	100-240	15	7.5	2000			
FY0753000	100-240	22.5	7.5	3000			
FY0754000	100-240	30	7.5	4000			
FY0755000	100-240	37.5	7.5	5000			
FY0756000	100-240	45	7.5	6000			
FY0757000	100-240	52.5	7.5	7000			
FY0757500	100-240	56.25	7.5	7500			
FY0850300	100-240	2.55	8.5	300	2X0.9MM 4T	20A 45V	1000uF 16V
FY0850400	100-240	3.4	8.5	400			
FY0850500	100-240	4.25	8.5	500			
FY0850600	100-240	5.1	8.5	600			
FY0850700	100-240	5.95	8.5	700			
FY0850800	100-240	6.8	8.5	800			
FY0850900	100-240	7.65	8.5	900			
FY0851000	100-240	8.5	8.5	1000			
FY0851500	100-240	12.75	8.5	1500			
FY0852000	100-240	17	8.5	2000			
FY0853000	100-240	25.5	8.5	3000			
FY0854000	100-240	34	8.5	4000			
FY0855000	100-240	42.5	8.5	5000			
FY0856000	100-240	51	8.5	6000			
FY0857000	100-240	59.5	8.5	7000			
FY0857500	100-240	63.75	8.5	7500			
FY0900300	100-240	2.7	9	300	2X0.9MM 4T	20A 45V	1000uF 16V
FY0900400	100-240	3.6	9	400			
FY0900500	100-240	4.5	9	500			
FY0900600	100-240	5.4	9	600			
FY0900700	100-240	6.3	9	700			
FY0900800	100-240	7.2	9	800			
FY0900900	100-240	8.1	9	900			
FY0901000	100-240	9	9	1000			
FY0901500	100-240	13.5	9	1500			
FY0902000	100-240	18	9	2000			
FY0903000	100-240	27	9	3000			
FY0904000	100-240	36	9	4000			
FY0905000	100-240	45	9	5000			
FY0906000	100-240	54	9	6000			
FY0907000	100-240	63	9	7000			
FY0907500	100-240	67.5	9	7500			
FY1000300	100-240	3	10	300	2X0.9MM 4T	20A 45V	1000uF 16V
FY1000400	100-240	4	10	400			
FY1000500	100-240	5	10	500			
FY1000600	100-240	6	10	600			
FY1000700	100-240	7	10	700			

FY1000800	100-240	8	10	800			
FY1000900	100-240	9	10	900			
FY1001000	100-240	10	10	1000			
FY1001500	100-240	15	10	1500			
FY1002000	100-240	20	10	2000			
FY1003000	100-240	30	10	3000			
FY1004000	100-240	40	10	4000			
FY1005000	100-240	50	10	5000			
FY1006000	100-240	60	10	6000			
FY1007000	100-240	70	10	7000			
FY1007500	100-240	75	10	7500			
FY1200300	100-240	3.6	12	300	2X0.9MM 4T	20A 45V	1000uF 16V
FY1200400	100-240	4.8	12	400			
FY1200500	100-240	6	12	500			
FY1200600	100-240	7.2	12	600			
FY1200700	100-240	8.4	12	700			
FY1200800	100-240	9.6	12	800			
FY1200900	100-240	10.8	12	900			
FY1201000	100-240	12	12	1000			
FY1201500	100-240	18	12	1500			
FY1202000	100-240	24	12	2000			
FY1203000	100-240	36	12	3000			
FY1204000	100-240	48	12	4000			
FY1205000	100-240	60	12	5000			
FY1206000	100-240	72	12	6000			
FY1207000	100-240	84	12	7000			
FY1207500	100-240	90	12	7500			
JFY1260300	100-240	3.78	12.6	300			
FY1260400	100-240	5.04	12.6	400			
FY1260500	100-240	6.3	12.6	500			
FY1260600	100-240	7.56	12.6	600			
FY1260700	100-240	8.82	12.6	700			
FY1260800	100-240	10.08	12.6	800			
FY1260900	100-240	11.34	12.6	900			
FY1261000	100-240	12.6	12.6	1000			
FY1261500	100-240	18.9	12.6	1500			
FY1262000	100-240	25.2	12.6	2000			
FY1263000	100-240	37.8	12.6	3000			
FY1264000	100-240	50.4	12.6	4000			
FY1265000	100-240	63	12.6	5000			
FY1266000	100-240	75.6	12.6	6000			
FY1267000	100-240	88.2	12.6	7000			
FY1267500	100-240	94.5	12.6	7500			
FY1350300	100-240	4.05	13.5	300	2X0.9MM 5T	20A 80V	1000uF 16V
FY1350400	100-240	5.4	13.5	400			
FY1350500	100-240	6.75	13.5	500			

FY1350600	100-240	8.1	13.5	600			
FY1350700	100-240	9.45	13.5	700			
FY1350800	100-240	10.8	13.5	800			
FY1350900	100-240	12.15	13.5	900			
FY1351000	100-240	13.5	13.5	1000			
FY1351500	100-240	20.25	13.5	1500			
FY1352000	100-240	27	13.5	2000			
FY1353000	100-240	40.5	13.5	3000			
FY1354000	100-240	54	13.5	4000			
FY1355000	100-240	67.5	13.5	5000			
FY1356000	100-240	81	13.5	6000			
FY1357000	100-240	94.5	13.5	7000			
FY1500300	100-240	4.5	15	300	2X0.9MM 5T	20A 80V	1000uF 25V
FY1500400	100-240	6	15	400			
FY1500500	100-240	7.5	15	500			
FY1500600	100-240	9	15	600			
FY1500700	100-240	10.5	15	700			
FY1500800	100-240	12	15	800			
FY1500900	100-240	13.5	15	900			
FY1501000	100-240	15	15	1000			
FY1501500	100-240	22.5	15	1500			
FY1502000	100-240	30	15	2000			
FY1503000	100-240	45	15	3000			
FY1504000	100-240	60	15	4000			
FY1505000	100-240	75	15	5000			
FY1506000	100-240	90	15	6000			
FY1507000	100-240	105	15	7000			
FY1600300	100-240	4.8	16	300	2X0.9MM 5T	20A 80V	1000uF 25V
FY1600400	100-240	6.4	16	400			
FY1600500	100-240	8	16	500			
FY1600600	100-240	9.6	16	600			
FY1600700	100-240	11.2	16	700			
FY1600800	100-240	12.8	16	800			
FY1600900	100-240	14.4	16	900			
FY1601000	100-240	16	16	1000			
FY1601500	100-240	24	16	1500			
FY1602000	100-240	32	16	2000			
FY1603000	100-240	48	16	3000			
FY1603750	100-240	60	16	3750			
FY1604000	100-240	64	16	4000			
FY1605000	100-240	80	16	5000			
FY1606000	100-240	96	16	6000			
FY1700300	100-240	5.1	17	300	2X0.9MM 6T	20A 80V	1000uF 25V
FY1700500	100-240	6.8	17	400			
FY1700500	100-240	8.5	17	500			
FY1700600	100-240	10.2	17	600			

FY1700700	100-240	11.9	17	700			
FY1700800	100-240	13.6	17	800			
FY1700900	100-240	15.3	17	900			
FY1701000	100-240	17	17	1000			
FY1701500	100-240	25.5	17	1500			
FY1702000	100-240	34	17	2000			
FY1703000	100-240	51	17	3000			
FY1704000	100-240	68	17	4000			
FY1705000	100-240	85	17	5000			
FY1706000	100-240	102	17	6000			
FY1800300	100-240	5.4	18	300	2X0.9MM 6T	20A 100V	1000uF 25V
FY1800400	100-240	7.2	18	400			
FY1800500	100-240	9	18	500			
FY1800600	100-240	10.8	18	600			
FY1800700	100-240	12.6	18	700			
FY1800800	100-240	14.4	18	800			
FY1800900	100-240	16.2	18	900			
FY1801000	100-240	18	18	1000			
FY1801500	100-240	27	18	1500			
FY1802000	100-240	36	18	2000			
FY1803000	100-240	54	18	3000			
FY1804000	100-240	72	18	4000			
FY1805000	100-240	90	18	5000			
FY1806000	100-240	108	18	6000			
FY1900300	100-240	5.7	19	300	2X0.9MM 6T	20A 100V	1000uF 25V
FY1900400	100-240	7.6	19	400			
FY1900500	100-240	9.5	19	500			
FY1900600	100-240	11.4	19	600			
FY1900700	100-240	13.3	19	700			
FY1900800	100-240	15.2	19	800			
FY1900900	100-240	17.1	19	900			
FY1901000	100-240	19	19	1000			
FY1901500	100-240	28.5	19	1500			
FY1902000	100-240	38	19	2000			
FY1903000	100-240	57	19	3000			
FY1903150	100-240	59.85	19	3150			
FY1904000	100-240	76	19	4000			
FY1904750	100-240	90.25	19	4750			
FY1905000	100-240	95	19	5000			
FY1906000	100-240	114	19	6000			
FY2100300	100-240	6.3	21	300	2X0.9MM 6T	20A 100V	1000uF 25V
FY2100400	100-240	8.4	21	400			
FY2100500	100-240	10.5	21	500			
FY2100600	100-240	12.6	21	600			
FY2100700	100-240	14.7	21	700			
FY2100800	100-240	16.8	21	800			

FY2100900	100-240	18.9	21	900						
FY2101000	100-240	21	21	1000						
FY2101500	100-240	31.5	21	1500						
FY2102000	100-240	42	21	2000						
FY2103000	100-240	63	21	3000						
FY2104000	100-240	84	21	4000						
FY2105000	100-240	105	21	5000						
FY2400300	100-240	7.2	24	300	2X0.9MM 7T	20A 150V	470uF 35V			
FY2400400	100-240	9.6	24	400						
FY2400500	100-240	12	24	500						
FY2400600	100-240	14.4	24	600						
FY2400700	100-240	16.8	24	700						
FY2400800	100-240	19.2	24	800						
FY2400900	100-240	21.6	24	900						
FY2401000	100-240	24	24	1000						
FY2401500	100-240	36	24	1500						
FY2402000	100-240	48	24	2000						
FY2402500	100-240	60	24	2500						
FY2403000	100-240	72	24	3000						
FY2403500	100-240	84	24	3500						
FY2404000	100-240	96	24	4000						
FY2404500	100-240	108	24	4500						
FY2405000	100-240	120	24	5000						
FY2550300	100-240	7.65	25.5	300	2X0.9MM 7T	20A 150V	470uF 35V			
FY2550400	100-240	10.2	25.5	400						
FY2550500	100-240	12.75	25.5	500						
FY2550600	100-240	15.3	25.5	600						
FY2550700	100-240	17.85	25.5	700						
FY2550800	100-240	20.4	25.5	800						
FY2550900	100-240	22.95	25.5	900						
FY2551000	100-240	25.5	25.5	1000						
FY2551500	100-240	38.25	25.5	1500						
FY2552000	100-240	51	25.5	2000						
FY2552500	100-240	63.75	25.5	2500						
FY2553000	100-240	76.5	25.5	3000						
FY2553500	100-240	89.25	25.5	3500						
FY2554000	100-240	102	25.5	4000						
FY2554500	100-240	114.75	25.5	4500						
FY2900300	100-240	8.7	29	300				2X0.9MM 9T	20A 150V	470uF 35V
FY2900400	100-240	11.6	29	400						
FY2900500	100-240	14.5	29	500						
FY2900600	100-240	17.4	29	600						
FY2900700	100-240	20.3	29	700						
FY2900800	100-240	23.2	29	800						
FY2900900	100-240	26.1	29	900						
FY2901000	100-240	29	29	1000						

FY2901500	100-240	43.5	29	1500			
FY2902000	100-240	58	29	2000			
FY2902500	100-240	72.5	29	2500			
FY2903000	100-240	87	29	3000			
FY2903500	100-240	101.5	29	3500			
FY2904000	100-240	116	29	4000			
FY3000300	100-240	9	30	300	2X0.9MM 9T	20A 150V	470uF 35V
FY3000400	100-240	12	30	400			
FY3000500	100-240	15	30	500			
FY3000600	100-240	18	30	600			
FY3000700	100-240	21	30	700			
FY3000800	100-240	24	30	800			
FY3000900	100-240	27	30	900			
FY3001000	100-240	30	30	1000			
FY3001500	100-240	45	30	1500			
FY3002000	100-240	60	30	2000			
FY3002500	100-240	75	30	2500			
FY3003000	100-240	90	30	3000			
FY3003500	100-240	105	30	3500			
FY3400300	100-240	10.2	34	300	2X0.9MM 10T	20A 150V	470uF 50V
FY3400400	100-240	13.6	34	400			
FY3400500	100-240	17	34	500			
FY3400600	100-240	20.4	34	600			
FY3400700	100-240	23.8	34	700			
FY3400800	100-240	27.2	34	800			
FY3400900	100-240	30.6	34	900			
FY3401000	100-240	34	34	1000			
FY3401500	100-240	51	34	1500			
FY3402000	100-240	68	34	2000			
FY3402500	100-240	85	34	2500			
FY3403000	100-240	102	34	3000			
FY3600300	100-240	10.8	36	300	2X0.9MM 10T	20A 150V	470uF 50V
FY3600400	100-240	14.4	36	400			
FY3600500	100-240	18	36	500			
FY3600600	100-240	21.6	36	600			
FY3600700	100-240	25.2	36	700			
FY3600800	100-240	28.8	36	800			
FY3600900	100-240	32.4	36	900			
FY3601000	100-240	36	36	1000			
FY3601500	100-240	54	36	1500			
FY3602000	100-240	72	36	2000			
FY3602500	100-240	90	36	2500			
FY3603000	100-240	108	36	3000			
FY3800300	100-240	11.4	38	300	2X0.9MM 11T	16A 200V	470uF 50V
FY3800400	100-240	15.2	38	400			

FY3800500	100-240	19	38	500			
FY3800600	100-240	22.8	38	600			
FY3800700	100-240	26.6	38	700			
FY3800800	100-240	30.4	38	800			
FY3800900	100-240	34.2	38	900			
FY3801000	100-240	38	38	1000			
FY3801500	100-240	57	38	1500			
FY3802000	100-240	76	38	2000			
FY3802500	100-240	95	38	2500			
FY3803000	100-240	114	38	3000			
FY4250300	100-240	12.75	42.5	300	2X0.9MM 12T	16A 200V	470uF 50V
FY4250400	100-240	17	42.5	400			
FY4250500	100-240	21.25	42.5	500			
FY4250600	100-240	25.5	42.5	600			
FY4250700	100-240	29.75	42.5	700			
FY4250800	100-240	34	42.5	800			
FY4250900	100-240	38.25	42.5	900			
FY4251000	100-240	42.5	42.5	1000			
FY4251500	100-240	63.75	42.5	1500			
FY4252000	100-240	85	42.5	2000			
FY4252500	100-240	106.25	42.5	2500			
FY4252800	100-240	119	42.5	2800			
FY4300300	100-240	12.9	43	300	2X0.9MM 12T	10A 200V	470uF 50V
FY4300400	100-240	17.2	43	400			
FY4300500	100-240	21.5	43	500			
FY4300600	100-240	25.8	43	600			
FY4300700	100-240	30.1	43	700			
FY4300800	100-240	34.4	43	800			
FY4300900	100-240	38.7	43	900			
FY4301000	100-240	43	43	1000			
FY4301500	100-240	64.5	43	1500			
FY4302000	100-240	86	43	2000			
FY4302500	100-240	107.5	43	2500			
FY4302700	100-240	116.1	43	2700			
FY4400300	100-240	13.2	44	300	2X0.9MM 12T	16A 200V	470uF 50V
FY4400400	100-240	17.6	44	400			
FY4400500	100-240	22	44	500			
FY4400600	100-240	26.4	44	600			
FY4400700	100-240	30.8	44	700			
FY4400800	100-240	35.2	44	800			
FY4400900	100-240	39.6	44	900			
FY4401000	100-240	44	44	1000			
FY4401500	100-240	66	44	1500			
FY4402000	100-240	88	44	2000			
FY4402500	100-240	110	44	2500			
FY4402700	100-240	118.8	44	2700			

FY4500300	100-240	13.5	45	300	2X0.9MM 12T	16A 200V	470uF 50V
FY4500400	100-240	18	45	400			
FY4500500	100-240	22.5	45	500			
FY4500600	100-240	27	45	600			
FY4500700	100-240	31.5	45	700			
FY4500800	100-240	36	45	800			
FY4500900	100-240	40.5	45	900			
FY4501000	100-240	45	45	1000			
FY4501500	100-240	67.5	45	1500			
FY4502000	100-240	90	45	2000			
FY4502500	100-240	112.5	45	2500			
FY4600300	100-240	13.8	46	300	2X0.9MM 12T	16A 200V	470uF 50V
FY4600400	100-240	18.4	46	400			
FY4600500	100-240	23	46	500			
FY4600600	100-240	27.6	46	600			
FY4600700	100-240	32.2	46	700			
FY4600800	100-240	36.8	46	800			
FY4600900	100-240	41.4	46	900			
FY4601000	100-240	46	46	1000			
FY4601500	100-240	69	46	1500			
FY4602000	100-240	92	46	2000			
FY4602500	100-240	115	46	2500			
FY4800300	100-240	14.4	48	300	2X0.8MM 12T	16A 200V	330uF 63V
FY4800400	100-240	19.2	48	400			
FY4800500	100-240	24	48	500			
FY4800600	100-240	28.8	48	600			
FY4800700	100-240	33.6	48	700			
FY4800800	100-240	38.4	48	800			
FY4800900	100-240	43.2	48	900			
FY4801000	100-240	48	48	1000			
FY4801500	100-240	72	48	1500			
FY4802000	100-240	96	48	2000			
FY4802500	100-240	120	48	2500			
FY5100300	100-240	15.3	51	300	2X0.9MM 14T	16A 200V	330uF 63V
FY5100400	100-240	20.4	51	400			
FY5100500	100-240	25.5	51	500			
FY5100600	100-240	30.6	51	600			
FY5100700	100-240	35.7	51	700			
FY5100800	100-240	40.8	51	800			
FY5100900	100-240	45.9	51	900			
FY5101000	100-240	51	51	1000			
FY5101500	100-240	76.5	51	1500			
FY5102000	100-240	102	51	2000			
FY5102200	100-240	112.2	51	2200			

FY5502000	100-240	116	55	2000	2X0.9MM 14T	16A 200V	330uF 63V
FY5800300	100-240	17.4	58	300	2X0.9MM 14T	16A 200V	330uF 63V
FY5800400	100-240	23.2	58	400			
FY5800500	100-240	29	58	500			
FY5800600	100-240	34.8	58	600			
FY5800700	100-240	40.6	58	700			
FY5800800	100-240	46.4	58	800			
FY5800900	100-240	52.2	58	900			
FY5801000	100-240	58	58	1000			
FY5801500	100-240	87	58	1500			
FY5802000	100-240	116	58	2000			

This report is based on CB test report 12014620 001 except for below changes:

1. Upgrade standard from IEC 60950-1:2001 to IEC 60950-1: 2005 + A1: 2009.

2. Following changes were made in the components list:

Change the manufacturer name of inlet type ST-A03-005 from "Yue Qing Bei Er Jia Electronic Co. Ltd." to "Zhe Jiang Bei Er Jia Electronic Co., Ltd."

Change the fuse (CF1) type PDU series from "Walter Electronic Co. Ltd." to "Conquer Electronics Co., Ltd."

Change the type name of fuse (CF1) of "Shenzhen Lanson Electronics Co. Ltd." from "Txxx250V" to "3K T3,15A250V".

Change the type name of enclosure from 920/923 to 920(f1)/923(f1).

Change the manufacturer name of enclosure type "920(f1)/923(f1)" from "GE PLASTICS CHINA LTD" to "SABIC INNOVATIVE PLASTICS US L L C". The character and performance of the material didn't change.

Delete the insulating tape of PT1 and L1 type DEJZ3.

Change the type name of shrinkable tubing of CHANGYUAN ELECTRONICS(SHENZHEN) from "Changbao 102" to "CB-HFT".

Change the certificate number of magnet wire of PT1 and L1 type UEW of XIN LONG MAGNET WIRE CO LTD from E171028 to E171082.

Change the certificate number of optocoupler (IC2) type TCET1114G from 115667 to 40028080.

3. US, CA, CN, JP and KR national differences were added.

Abbreviations used in the report:

- normal conditions	N.C.	- single fault conditions	S.F.C
- functional insulation	OP	- basic insulation	BI
- double insulation	DI	- supplementary insulation	SI
- between parts of opposite polarity	BOP	- reinforced insulation	RI

IEC 60950-1			
Clause	Requirement + Test	Result - Remark	Verdict
1	GENERAL		P
1.5	Components		P
1.5.1	General		P
	Comply with IEC 60950-1 or relevant component standard	(see appended tables 1.5.1)	P
1.5.2	Evaluation and testing of components	Components which are certified to IEC and/or national standards are used correctly within their ratings. Components not covered by IEC standards are tested under the conditions present in the equipment.	P
1.5.3	Thermal controls	No thermal controls.	N/A
1.5.4	Transformers	Transformers used are suitable for their intended application and comply with the relevant requirements of the standard and particularly Annex C.	P
1.5.5	Interconnecting cables	SELV output cable provided as part of this equipment and no higher available energy than 240VA, no possible hazard.	P
1.5.6	Capacitors bridging insulation	Between the line and neutral: X2 capacitor (C1) according to IEC 60384-14. Between primary and secondary: Y1 capacitor (C9) according to IEC 60384-14.	P
1.5.7	Resistors bridging insulation	No such resistors used	N/A
1.5.7.1	Resistors bridging functional, basic or supplementary insulation		N/A
1.5.7.2	Resistors bridging double or reinforced insulation between a.c. mains and other circuits	.	N/A
1.5.7.3	Resistors bridging double or reinforced insulation between a.c. mains and antenna or coaxial cable		N/A
1.5.8	Components in equipment for IT power systems		N/A

IEC 60950-1			
Clause	Requirement + Test	Result - Remark	Verdict
1.5.9	Surge suppressors	No surge suppressors used.	N/A
1.5.9.1	General		N/A
1.5.9.2	Protection of VDRs		N/A
1.5.9.3	Bridging of functional insulation by a VDR		N/A
1.5.9.4	Bridging of basic insulation by a VDR		N/A
1.5.9.5	Bridging of supplementary, double or reinforced insulation by a VDR		N/A

1.6	Power interface		P
1.6.1	AC power distribution systems	TN power system	P
1.6.2	Input current	Highest load according to 1.2.2.1 for this equipment is the operation with the maximum specified by the manual instruction. (see appended table 1.6.2)	P
1.6.3	Voltage limit of hand-held equipment	This appliance is not hand-held equipment.	N/A
1.6.4	Neutral conductor	The neutral conductor insulated from earth and from the body throughout the equipment as if it were a line conductor	P

1.7	Marking and instructions		P
1.7.1	Power rating and identification markings	See below	P
1.7.1.1	Power rating marking		P
	Multiple mains supply connections.....:	Single power source	P
	Rated voltage(s) or voltage range(s) (V)	100-240V~	P
	Symbol for nature of supply, for d.c. only	AC source	P
	Rated frequency or rated frequency range (Hz) ... :	50/60Hz	P
	Rated current (mA or A)	See page 2 for details	P
1.7.1.2	Identification markings		P
	Manufacturer's name or trade-mark or identification mark	Fuyuan Electronic Co., Ltd.	P
	Model identification or type reference	See page 6-16.	P
	Symbol for Class II equipment only	IEC 60417-5172 symbol marked.	P

IEC 60950-1			
Clause	Requirement + Test	Result - Remark	Verdict
	Other markings and symbols	Additional symbol or marking does not give rise to misunderstanding	P
1.7.2	Safety instructions and marking	English and Japanese version provided.	P
1.7.2.1	General		P
1.7.2.2	Disconnect devices	AC appliance inlet provided.	P
1.7.2.3	Overcurrent protective device	Not such equipment.	N/A
1.7.2.4	IT power distribution systems		N/A
1.7.2.5	Operator access with a tool	No operator accessible area that needs to be accessed by the use of a tool.	N/A
1.7.2.6	Ozone	Not such equipment.	N/A
1.7.3	Short duty cycles	Equipment is designed for continuous operation.	N/A
1.7.4	Supply voltage adjustment	No voltage selector.	N/A
	Methods and means of adjustment; reference to installation instructions		N/A
1.7.5	Power outlets on the equipment	No power outlets provided.	N/A
1.7.6	Fuse identification (marking, special fusing characteristics, cross-reference)	Soldered-in fuse not located in operator access area, "CF1 3.15A, 250V" marked close to current fuse on PCB.	P
1.7.7	Wiring terminals	See below.	P
1.7.7.1	Protective earthing and bonding terminals	Class II equipment.	N/A
1.7.7.2	Terminals for a.c. mains supply conductors	No such terminals provide.	N/A
1.7.7.3	Terminals for d.c. mains supply conductors	No such terminals provide.	N/A
1.7.8	Controls and indicators	No controls and indicators affect to safety provided	N/A
1.7.8.1	Identification, location and marking	No switches and controls.	N/A
1.7.8.2	Colours		N/A
1.7.8.3	Symbols according to IEC 60417	No symbols used.	N/A
1.7.8.4	Markings using figures	No indicators for different positions.	N/A
1.7.9	Isolation of multiple power sources	Single power source	N/A
1.7.10	Thermostats and other regulating devices	Such devices not used.	N/A

IEC 60950-1			
Clause	Requirement + Test	Result - Remark	Verdict
1.7.11	Durability	The label was subjected to the permanence of marking test. The label was rubbed with cloth soaked with water for 15 sec. And then again for 15 sec. with the cloth soaked with petroleum spirit. After this test there was no damage to the label. The marking on the label did not fade. There was no curling nor lifting of the label edge.	P
1.7.12	Removable parts	No removable part.	N/A
1.7.13	Replaceable batteries	No battery provided.	N/A
	Language(s)		—
1.7.14	Equipment for restricted access locations.....	Not intended for use in restricted access locations.	N/A

2	PROTECTION FROM HAZARDS		P
2.1	Protection from electric shock and energy hazards		P
2.1.1	Protection in operator access areas	No access with test finger and test pin to any hazardous parts.	P
2.1.1.1	Access to energized parts	See above.	P
	Test by inspection		P
	Test with test finger (Figure 2A)		P
	Test with test pin (Figure 2B)		P
	Test with test probe (Figure 2C)		N/A
2.1.1.2	Battery compartments	No battery compartment.	N/A
2.1.1.3	Access to ELV wiring	No ELV wiring in operator accessible area.	N/A
	Working voltage (V_{peak} or V_{rms}); minimum distance through insulation (mm)	(see appended table 2.10.5)	—
2.1.1.4	Access to hazardous voltage circuit wiring	No hazardous voltage wiring in operator accessible area.	N/A

IEC 60950-1			
Clause	Requirement + Test	Result - Remark	Verdict
2.1.1.5	Energy hazards	The energy does not exceed 240VA between any two points in accessible part of cradle and accessible connector of secondary circuit of adapter. (see appended table 2.1.1.5.)	P
2.1.1.6	Manual controls	No manual controls.	N/A
2.1.1.7	Discharge of capacitors in equipment	Not tested because of X2-cap C1 = 0.1µF	N/A
	Measured voltage (V); time-constant (s)		—
2.1.1.8	Energy hazards – d.c. mains supply	Connected to a.c. mains.	N/A
	a) Capacitor connected to the d.c. mains supply ..		N/A
	b) Internal battery connected to the d.c. mains supply		N/A
2.1.1.9	Audio amplifiers	Not such equipment.	N/A
2.1.2	Protection in service access areas	No operator accessible area that needs to be accessed by the use of a tool.	N/A
2.1.3	Protection in restricted access locations	Not intended for use in restricted access locations.	N/A

2.2	SELV circuits		P
2.2.1	General requirements	The secondary circuits were tested as SELV. See 2.2.2 to 2.2.4.	P
2.2.2	Voltages under normal conditions (V)	Between any conductors of the SELV circuits of adapter, 42.4 V peak or 60 V d.c. are not exceeded. See appended table 2.2.	P
2.2.3	Voltages under fault conditions (V)	Single fault did not cause excessive voltage in accessible SELV circuits. Limits of 71V peak and 120V d.c. were not exceeded within 0.2 seconds and limits 42.4V peak and 60V d.c. were not exceeded for longer than 0.2 seconds.	P

IEC 60950-1			
Clause	Requirement + Test	Result - Remark	Verdict
2.2.4	Connection of SELV circuits to other circuits	See sub-clauses 2.2.2 and 2.2.3. and 2.4.2	P

2.3	TNV circuits	<i>No TNV circuits used</i>	N/A
2.3.1	Limits		N/A
	Type of TNV circuits		—
2.3.2	Separation from other circuits and from accessible parts		N/A
2.3.2.1	General requirements		N/A
2.3.2.2	Protection by basic insulation		N/A
2.3.2.3	Protection by earthing		N/A
2.3.2.4	Protection by other constructions		N/A
2.3.3	Separation from hazardous voltages		N/A
	Insulation employed.....		—
2.3.4	Connection of TNV circuits to other circuits		N/A
	Insulation employed.....		—
2.3.5	Test for operating voltages generated externally		N/A

2.4	Limited current circuits		P
2.4.1	General requirements	See below.	P
2.4.2	Limit values	(see appended table 2.4.2)	P
	Frequency (Hz).....	(see appended table 2.4.2)	—
	Measured current (mA).....	The peak drop voltage was measured with an oscilloscope at a 2kΩ non-inductive resistor. Results see appended table 2.4.2.	—
	Measured voltage (V)	<450Vpeak	—
	Measured circuit capacitance (nF or μF).....	C9=2200pF	—
2.4.3	Connection of limited current circuits to other circuits	Output circuit as limited current circuit connected to primary via one bridging capacitor (C9).	P

2.5	Limited power sources	<i>Not required</i>	N/A
	a) Inherently limited output		N/A
	b) Impedance limited output		N/A

IEC 60950-1			
Clause	Requirement + Test	Result - Remark	Verdict
	c) Regulating network limited output under normal operating and single fault condition		N/A
	d) Overcurrent protective device limited output		N/A
	Max. Output voltage (V), max. Output current (A), max. Apparent power (VA)		—
	Current rating of overcurrent protective device (A) .:		—
	Use of integrated circuit (IC) current limiters		

2.6	Provisions for earthing and bonding	<i>Class II equipment</i>	N/A
2.6.1	Protective earthing		N/A
2.6.2	Functional earthing		N/A
2.6.3	Protective earthing and protective bonding conductors		N/A
2.6.3.1	General		N/A
2.6.3.2	Size of protective earthing conductors		N/A
	Rated current (A), cross-sectional area (mm ²), AWG		—
2.6.3.3	Size of protective bonding conductors		N/A
	Rated current (A), cross-sectional area (mm ²), AWG		—
	Protective current rating (A), cross-sectional area (mm ²), AWG		—
2.6.3.4	Resistance of earthing conductors and their terminations; resistance (Ω), voltage drop (V), test current (A), duration (min)		N/A
2.6.3.5	Colour of insulation		N/A
2.6.4	Terminals		N/A
2.6.4.1	General		N/A
2.6.4.2	Protective earthing and bonding terminals		N/A
	Rated current (A), type, nominal thread diameter (mm)		—
2.6.4.3	Separation of the protective earthing conductor from protective bonding conductors		N/A
2.6.5	Integrity of protective earthing		N/A
2.6.5.1	Interconnection of equipment		N/A
2.6.5.2	Components in protective earthing conductors and protective bonding conductors		N/A

IEC 60950-1			
Clause	Requirement + Test	Result - Remark	Verdict
2.6.5.3	Disconnection of protective earth		N/A
2.6.5.4	Parts that can be removed by an operator		N/A
2.6.5.5	Parts removed during servicing		N/A
2.6.5.6	Corrosion resistance		N/A
2.6.5.7	Screws for protective bonding		N/A
2.6.5.8	Reliance on telecommunication network or cable distribution system		N/A

2.7	Overcurrent and earth fault protection in primary circuits		P
2.7.1	Basic requirements	A soldered-in fuse located in circuits used as protective device against overcurrents, short circuits. Circuit breaker in building installation used as backup protection.	P
	Instructions when protection relies on building installation	Pluggable equipment type A.	N/A
2.7.2	Faults not simulated in 5.3.7	The protection devices are well dimensioned and mounted.	P
2.7.3	Short-circuit backup protection	Building installation is considered as providing short-circuit backup protection.	P
2.7.4	Number and location of protective devices	Overcurrent protection by a soldered-in fuse.	P
2.7.5	Protection by several devices	Protection provided by a soldered-in fuse only.	N/A
2.7.6	Warning to service personnel	No service work necessary.	N/A

2.8	Safety interlocks	<i>No safety interlocks used</i>	N/A
2.8.1	General principles		N/A
2.8.2	Protection requirements		N/A
2.8.3	Inadvertent reactivation		N/A
2.8.4	Fail-safe operation		N/A
	Protection against extreme hazard		N/A
2.8.5	Moving parts		N/A
2.8.6	Overriding		N/A
2.8.7	Switches, relays and their related circuits		N/A

IEC 60950-1			
Clause	Requirement + Test	Result - Remark	Verdict
2.8.7.1	Separation distances for contact gaps and their related circuits (mm)		N/A
2.8.7.2	Overload test		N/A
2.8.7.3	Endurance test		N/A
2.8.7.4	Electric strength test	(see appended table 5.2)	N/A
2.8.8	Mechanical actuators		N/A

2.9	Electrical insulation		P
2.9.1	Properties of insulating materials	Natural rubber, asbestos or hygroscopic material not used.	P
2.9.2	Humidity conditioning	30°C, 95% R.H. for 48h	P
	Relative humidity (%), temperature (°C)	See above.	—
2.9.3	Grade of insulation	The adequate levels of safety insulation provided and maintained to comply with the requirements of this standard.	P
2.9.4	Separation from hazardous voltages		P
	Method(s) used	SELV separated from primary by reinforced or double insulation.	—

2.10	Clearances, creepage distances and distances through insulation		P
2.10.1	General	See 2.10.3, 2.10.4 and 2.10.5.	P
2.10.1.1	Frequency	40-60kHz generated internally	P
2.10.1.2	Pollution degrees	2	P
2.10.1.3	Reduced values for functional insulation	Considered	P
2.10.1.4	Intervening unconnected conductive parts	Considered	P
2.10.1.5	Insulation with varying dimensions	Insulation kept homogenous.	N/A
2.10.1.6	Special separation requirements	Not applied.	N/A
2.10.1.7	Insulation in circuits generating starting pulses	No such circuit.	N/A
2.10.2	Determination of working voltage		P

IEC 60950-1			
Clause	Requirement + Test	Result - Remark	Verdict
2.10.2.1	General	The rms and the peak voltage were measured with unit connected to a 240V TN power system. Pollution Degree 2 and Overvoltage Category II considered.	P
2.10.2.2	RMS working voltage	(See appended table 2.10.2)	P
2.10.2.3	Peak working voltage	(See appended table 2.10.2)	P
2.10.3	Clearances	See below and advantage of annex G is not considered.	P
2.10.3.1	General	Considered.	P
2.10.3.2	Mains transient voltages		P
	a) AC mains supply	240V a.c. and Overvoltage Category II	P
	b) Earthed d.c. mains supplies		N/A
	c) Unearthed d.c. mains supplies		N/A
	d) Battery operation		N/A
2.10.3.3	Clearances in primary circuits	(see appended table 2.10.3 and 2.10.4)	P
2.10.3.4	Clearances in secondary circuits	Sub-clause 5.3.4 considered.	P
2.10.3.5	Clearances in circuits having starting pulses		N/A
2.10.3.6	Transients from a.c. mains supply	Normal transient voltage considered (overvoltage category II for primary circuit).	N/A
2.10.3.7	Transients from d.c. mains supply		N/A
2.10.3.8	Transients from telecommunication networks and cable distribution systems		N/A
2.10.3.9	Measurement of transient voltage levels		N/A
	a) Transients from a mains supply		N/A
	For an a.c. mains supply		N/A
	For a d.c. mains supply		N/A
	b) Transients from a telecommunication network :		N/A
2.10.4	Creepage distances	See appended table 2.10.3 and 2.10.4.	P
2.10.4.1	General	CTI rating for all materials of minimum 100.	P

IEC 60950-1			
Clause	Requirement + Test	Result - Remark	Verdict
2.10.4.2	Material group and comparative tracking index		P
	CTI tests	Material group IIIb is assumed to be used.	—
2.10.4.3	Minimum creepage distances	(see appended table 2.10.3 and 2.10.4)	P
2.10.5	Solid insulation		P
2.10.5.1	General	See below.	P
2.10.5.2	Distances through insulation	(see appended table 2.10.5)	P
2.10.5.3	Insulating compound as solid insulation	No such construction used.	N/A
2.10.5.4	Semiconductor devices	Approved opto-coupler used.	P
2.10.5.5.	Cemented joints	No such construction.	N/A
2.10.5.6	Thin sheet material – General		P
2.10.5.7	Separable thin sheet material	Used in transformer PT1	P
	Number of layers (pcs)	-3 layers insulation tape wrapped between primary soldering points, components and secondary heat sink as reinforced insulation -3 layers insulation tape wrapped between secondary soldering points, components and primary heat sink as reinforced insulation -3 layers insulation tape wrapped around external of transformer as reinforced insulation 2 layers of three layers passes dielectric strength test specified in 5.2 for reinforced insulation.	—
2.10.5.8	Non-separable thin sheet material	Not such material.	N/A
2.10.5.9	Thin sheet material – standard test procedure		N/A
	Electric strength test		—
2.10.5.10	Thin sheet material – alternative test procedure	(see appended table 5.2)	P
	Electric strength test		—
2.10.5.11	Insulation in wound components	Approved triple insulated wire used.	P
2.10.5.12	Wire in wound components		P
	Working voltage		P

IEC 60950-1			
Clause	Requirement + Test	Result - Remark	Verdict
	a) Basic insulation not under stress		N/A
	b) Basic, supplementary, reinforced insulation	Wire complies to Annex U, three layers insulation.	P
	c) Compliance with Annex U		P
	Two wires in contact inside wound component; angle between 45° and 90°	Insulating tape used to separate primary windings and secondary triple insulated wires in crossing section, also see appended table C.2.	P
2.10.5.13	Wire with solvent-based enamel in wound components	No such construction.	N/A
	Electric strength test		—
	Routine test		N/A
2.10.5.14	Additional insulation in wound components	No such construction.	N/A
	Working voltage		N/A
	- Basic insulation not under stress		N/A
	- Supplementary, reinforced insulation		N/A
2.10.6	Construction of printed boards	See below.	P
2.10.6.1	Uncoated printed boards	(see appended table 2.10.3 and 2.10.4)	P
2.10.6.2	Coated printed boards	No coated printed boards.	N/A
2.10.6.3	Insulation between conductors on the same inner surface of a printed board	No multi-layer PCBs provided.	N/A
2.10.6.4	Insulation between conductors on different layers of a printed board	No multi-layer PCBs provided.	N/A
	Distance through insulation		N/A
	Number of insulation layers (pcs).....	Single layer PCB	N/A
2.10.7	Component external terminations	(see appended table 2.10.3 and 2.10.4)	P
2.10.8	Tests on coated printed boards and coated components	No such boards and components	N/A
2.10.8.1	Sample preparation and preliminary inspection		N/A
2.10.8.2	Thermal conditioning		N/A
2.10.8.3	Electric strength test		N/A
2.10.8.4	Abrasion resistance test		N/A
2.10.9	Thermal cycling		N/A

IEC 60950-1			
Clause	Requirement + Test	Result - Remark	Verdict
2.10.10	Test for Pollution Degree 1 environment and insulating compound		N/A
2.10.11	Tests for semiconductor devices and cemented joints	Optocoupler is approved. No other such constructions	P
2.10.12	Enclosed and sealed parts	No hermetically sealed component.	N/A

3	WIRING, CONNECTIONS AND SUPPLY		P
3.1	General		P
3.1.1	Current rating and overcurrent protection	Internal wires are UL recognized wiring which is PVC insulated, rated VW-1 or FT-1, min.80°C, and having gauge suitable for current intended to be carried.	P
3.1.2	Protection against mechanical damage	Wires do not touch sharp edges which could damage the insulation and cause hazard.	P
3.1.3	Securing of internal wiring	Internal wires reliably soldered and fixed by gule.	P
3.1.4	Insulation of conductors	The insulation of the individual conductors suitable for the application and the working voltage. For the insulation material see 3.1.1.	P
3.1.5	Beads and ceramic insulators	Not used.	N/A
3.1.6	Screws for electrical contact pressure	No such screws provided.	N/A
3.1.7	Insulating materials in electrical connections	All current carrying connections are metal to metal.	N/A
3.1.8	Self-tapping and spaced thread screws	Not used.	N/A
3.1.9	Termination of conductors	The conductors of internal wires tightly soldered and additionally fixed by glue.	P
	10 N pull test	Force of 10 N applied to the termination points of the conductors.	P
3.1.10	Sleeving on wiring	No sleeving used as supplementary insulation on internal wire.	N/A

IEC 60950-1			
Clause	Requirement + Test	Result - Remark	Verdict

3.2	Connection to a mains supply		P
3.2.1	Means of connection	See below.	P
3.2.1.1	Connection to an a.c. mains supply	AC inlet.	P
3.2.1.2	Connection to a d.c. mains supply	Only a.c. mains supply.	N/A
3.2.2	Multiple supply connections	Only for one mains connection.	N/A
3.2.3	Permanently connected equipment	Unit is not a permanently connected equipment.	N/A
	Number of conductors, diameter of cable and conduits (mm)		—
3.2.4	Appliance inlets	VDE approved AC inlet used.	P
3.2.5	Power supply cords	Not provided.	N/A
3.2.5.1	AC power supply cords		N/A
	Type		—
	Rated current (A), cross-sectional area (mm ²), AWG		—
3.2.5.2	DC power supply cords	AC Source.	N/A
3.2.6	Cord anchorages and strain relief	No cord anchorage.	N/A
	Mass of equipment (kg), pull (N)		—
	Longitudinal displacement (mm)		—
3.2.7	Protection against mechanical damage		N/A
3.2.8	Cord guards		N/A
	Diameter or minor dimension D (mm); test mass (g)		—
	Radius of curvature of cord (mm)		—
3.2.9	Supply wiring space	Not permanent connection or non-detachable power cord type.	N/A

3.3	Wiring terminals for connection of external conductors	AC inlet used	N/A
3.3.1	Wiring terminals		N/A
3.3.2	Connection of non-detachable power supply cords		N/A
3.3.3	Screw terminals		N/A
3.3.4	Conductor sizes to be connected		N/A

IEC 60950-1			
Clause	Requirement + Test	Result - Remark	Verdict

	Rated current (A), cord/cable type, cross-sectional area (mm ²)..... :		—
3.3.5	Wiring terminal sizes		N/A
	Rated current (A), type, nominal thread diameter (mm)		—
3.3.6	Wiring terminal design		N/A
3.3.7	Grouping of wiring terminals		N/A
3.3.8	Stranded wire		N/A

3.4	Disconnection from the mains supply		P
3.4.1	General requirement	See below.....	P
3.4.2	Disconnect devices	AC inlet used	P
3.4.3	Permanently connected equipment	Not permanently connected equipment.	N/A
3.4.4	Parts which remain energized	No parts remained energized after disconnection of the appliance coupler.	P
3.4.5	Switches in flexible cords	None	N/A
3.4.6	Number of poles – single-phase and d.c. equipment	The appliance coupler disconnects both poles simultaneously	P
3.4.7	Number of poles – three-phase equipment	Single phase equipment.	N/A
3.4.8	Switches as disconnect devices		N/A
3.4.9	Plugs as disconnect devices		N/A
3.4.10	Interconnected equipment	Not interconnected equipment.	N/A
3.4.11	Multiple power sources	Only one supply connection provided.	N/A

3.5	Interconnection of equipment		P
3.5.1	General requirements	This power supply is not considered for connection to TNV.	P
3.5.2	Types of interconnection circuits	Interconnection circuits of SELV through the connector. No ELV interconnection circuits.	P
3.5.3	ELV circuits as interconnection circuits	No ELV interconnection	N/A

IEC 60950-1			
Clause	Requirement + Test	Result - Remark	Verdict
3.5.4	Data ports for additional equipment		N/A
4	PHYSICAL REQUIREMENTS		P
4.1	Stability		P
	Angle of 10°		P
	Test force (N)	Mass: less than 0.32kg	N/A
4.2	Mechanical strength		P
4.2.1	General	See below. After tests, unit complies with the requirements of sub-clauses 2.1.1 and 2.10.	P
	Rack-mounted equipment.		N/A
4.2.2	Steady force test, 10 N	10 N applied to all internal components.	P
4.2.3	Steady force test, 30 N	No internal enclosure.	N/A
4.2.4	Steady force test, 250 N	250 N applied to outer enclosure. No energy or other hazards.	P
4.2.5	Impact test	1.3m, 500g, 3times, after the test compliance was checked by 4.2.1	P
	Fall test	Performed.	P
	Swing test	Performed.	P
4.2.6	Drop test; height (mm)		N/A
4.2.7	Stress relief test	93(=82.2+10)°C, 7 hours. Tested on each material. After test, no shrinkage, distortion or loosening of any enclosure part was noticeable on the equipment.	P
4.2.8	Cathode ray tubes	No CRT in the unit.	N/A
	Picture tube separately certified		N/A
4.2.9	High pressure lamps	No high pressure lamp provided.	N/A
4.2.10	Wall or ceiling mounted equipment; force (N)	Not wall or ceiling mounted equipment.	N/A
4.3	Design and construction		P

IEC 60950-1			
Clause	Requirement + Test	Result - Remark	Verdict
4.3.1	Edges and corners	Edges and corners of the enclosure are rounded.	P
4.3.2	Handles and manual controls; force (N)	No handles or controls provided.	N/A
4.3.3	Adjustable controls	No such controls provided.	N/A
4.3.4	Securing of parts	Mechanical fixings in such a way designed that they will withstand mechanical stress occurring in normal use.	P
4.3.5	Connection by plugs and sockets	Mismatch of connectors either not possible or does not result in any hazard.	P
4.3.6	Direct plug-in equipment	Not direct plug-in equipment	N/A
	Torque		—
	Compliance with the relevant mains plug standard		N/A
4.3.7	Heating elements in earthed equipment	No heating elements provided.	N/A
4.3.8	Batteries	No batteries provided.	N/A
	- Overcharging of a rechargeable battery		N/A
	- Unintentional charging of a non-rechargeable battery		N/A
	- Reverse charging of a rechargeable battery		N/A
	- Excessive discharging rate for any battery		N/A
4.3.9	Oil and grease	No heating elements provided.	N/A
4.3.10	Dust, powders, liquids and gases	Equipment in intended use not considered to be exposed to these.	N/A
4.3.11	Containers for liquids or gases	No container for liquid or gas.	N/A
4.3.12	Flammable liquids	No such flammable liquid.	N/A
	Quantity of liquid (l)		N/A
	Flash point (°C)		N/A
4.3.13	Radiation	See 4.3.13.5	P
4.3.13.1	General		P
4.3.13.2	Ionizing radiation		N/A
	Measured radiation (pA/kg)		—

IEC 60950-1			
Clause	Requirement + Test	Result - Remark	Verdict
	Measured high-voltage (kV)		—
	Measured focus voltage (kV)		—
	CRT markings		—
4.3.13.3	Effect of ultraviolet (UV) radiation on materials		N/A
	Part, property, retention after test, flammability classification		N/A
4.3.13.4	Human exposure to ultraviolet (UV) radiation		N/A
4.3.13.5	Lasers (including laser diodes) and LEDs	See only below for LED.	P
4.3.13.5.1	Lasers (including laser diodes)		N/A
	Laser class		—
4.3.13.5.2	Light emitting diodes (LEDs)	The LED used in cradle for indication considered as inherently Class 1.	—
4.3.13.6	Other types		N/A

4.4	Protection against hazardous moving parts	<i>No moving parts</i>	N/A
4.4.1	General		N/A
4.4.2	Protection in operator access areas		N/A
	Household and home/office document/media shredders		N/A
4.4.3	Protection in restricted access locations		N/A
4.4.4	Protection in service access areas		N/A
4.4.5	Protection against moving fan blades		N/A
4.4.5.1	General		N/A
	Not considered to cause pain or injury. A).....		N/A
	Is considered to cause pain, not injury. B)		N/A
	Considered to cause injury. C)		N/A
4.4.5.2	Protection for users		N/A
	Use of symbol or warning		N/A
4.4.5.3	Protection for service persons		N/A
	Use of symbol or warning		N/A

4.5	Thermal requirements		P
4.5.1	General	Equipment loaded with rated output current.	P
4.5.2	Temperature tests	(see appended table 4.5)	P

IEC 60950-1			
Clause	Requirement + Test	Result - Remark	Verdict
	Normal load condition per Annex L	(see appended table 4.5)	—
4.5.3	Temperature limits for materials	(see appended table 4.5)	P
4.5.4	Touch temperature limits	(see appended table 4.5)	P
4.5.5	Resistance to abnormal heat	Phenolic bobbin material used in T1 which is acceptable without test.	P

4.6	Openings in enclosures		P
4.6.1	Top and side openings	No openings	P
	Dimensions (mm)		—
4.6.2	Bottoms of fire enclosures	No openings	P
	Construction of the bottom, dimensions (mm) ..		—
4.6.3	Doors or covers in fire enclosures		N/A
4.6.4	Openings in transportable equipment		N/A
4.6.4.1	Constructional design measures		N/A
	Dimensions (mm)		—
4.6.4.2	Evaluation measures for larger openings		N/A
4.6.4.3	Use of metallized parts		N/A
4.6.5	Adhesives for constructional purposes		N/A
	Conditioning temperature (°C), time (weeks)		—

4.7	Resistance to fire		P
4.7.1	Reducing the risk of ignition and spread of flame	No excessive temperatures. No easily burning materials employed. Fire enclosure provided.	P
	Method 1, selection and application of components wiring and materials	(see appended table 4.7)	P
	Method 2, application of all of simulated fault condition tests		N/A
4.7.2	Conditions for a fire enclosure		P

IEC 60950-1			
Clause	Requirement + Test	Result - Remark	Verdict
4.7.2.1	Parts requiring a fire enclosure	With having the following parts <ul style="list-style-type: none"> ▪ Components in primary ▪ Components in secondary circuits not supplied by limited power source ▪ Insulated wiring The fire enclosure is required.	P
4.7.2.2	Parts not requiring a fire enclosure		N/A
4.7.3	Materials		P
4.7.3.1	General	See below	P
4.7.3.2	Materials for fire enclosures	Min.V-0 fire enclosure used.	P
4.7.3.3	Materials for components and other parts outside fire enclosures		N/A
4.7.3.4	Materials for components and other parts inside fire enclosures	PCB rated V-0 or better. See appended table 1.5.1. Internal components except small parts are V-2, HF-2 or better.	P
4.7.3.5	Materials for air filter assemblies	No air filters provided.	N/A
4.7.3.6	Materials used in high-voltage components	No high voltage components provided.	N/A

5	ELECTRICAL REQUIREMENTS AND SIMULATED ABNORMAL CONDITIONS		P
5.1	Touch current and protective conductor current		P
5.1.1	General	See sub-clauses 5.1.2 to 5.1.6.	P
5.1.2	Configuration of equipment under test (EUT)	EUT has only one mains connection.	P
5.1.2.1	Single connection to an a.c. mains supply		P
5.1.2.2	Redundant multiple connections to an a.c. mains supply		N/A
5.1.2.3	Simultaneous multiple connections to an a.c. mains supply		N/A
5.1.3	Test circuit	Equipment of figure 5A used.	P
5.1.4	Application of measuring instrument	Using measuring instrument in annex D.	P

IEC 60950-1			
Clause	Requirement + Test	Result - Remark	Verdict
5.1.5	Test procedure	The touch current was measured from mains to DC output connector and to a 100 mm × 200 mm metal foil wrapped on accessible non-conductive parts (plastic enclosure).	P
5.1.6	Test measurements	(see appended table 5.1.6)	P
	Supply voltage (V)		—
	Measured touch current (mA)		—
	Max. Allowed touch current (mA)		—
	Measured protective conductor current (mA)		—
	Max. Allowed protective conductor current (mA) ..		—
5.1.7	Equipment with touch current exceeding 3,5 mA		N/A
5.1.7.1	General		N/A
5.1.7.2	Simultaneous multiple connections to the supply		N/A
5.1.8	Touch currents to telecommunication networks and cable distribution systems and from telecommunication networks	No TNV.	N/A
5.1.8.1	Limitation of the touch current to a telecommunication network or to a cable distribution system		N/A
	Supply voltage (V)		—
	Measured touch current (mA)		—
	Max. Allowed touch current (mA)		—
5.1.8.2	Summation of touch currents from telecommunication networks		N/A
	a) EUT with earthed telecommunication ports		N/A
	b) EUT whose telecommunication ports have no reference to protective earth		N/A

5.2	Electric strength		P
5.2.1	General	(see appended table 5.2)	P
5.2.2	Test procedure	(see appended table 5.2)	P

5.3	Abnormal operating and fault conditions		P
5.3.1	Protection against overload and abnormal operation	(see appended table 5.3)	P
5.3.2	Motors	No motors.	N/A

IEC 60950-1			
Clause	Requirement + Test	Result - Remark	Verdict
5.3.3	Transformers	Safety isolating transformer used, see table 5.3 for overload test and Annex C for construction	P
5.3.4	Functional insulation.....:	By short-circuited, results see appended table 5.3.	P
5.3.5	Electromechanical components	No electromechanical component .	N/A
5.3.6	Audio amplifiers in ITE	Audio amplifiers not used.	N/A
5.3.7	Simulation of faults	(see appended table 5.3.)	P
5.3.8	Unattended equipment	No such equipment.	N/A
5.3.9	Compliance criteria for abnormal operating and fault conditions		P
5.3.9.1	During the tests	No fire or molten metal occurred and no deformation of enclosure during the tests.	P
5.3.9.2	After the tests	No reduction of clearance and creepage distance. Electric strength test is made on basic, supplementary and reinforced insulation after test.	P

6	CONNECTION TO TELECOMMUNICATION NETWORKS <i>No TNV circuits</i>		N/A
6.1	Protection of telecommunication network service persons, and users of other equipment connected to the network, from hazards in the equipment		N/A
6.1.1	Protection from hazardous voltages		N/A
6.1.2	Separation of the telecommunication network from earth		N/A
6.1.2.1	Requirements		N/A
	Supply voltage (V)		—
	Current in the test circuit (mA)		—
6.1.2.2	Exclusions		N/A

6.2	Protection of equipment users from overvoltages on telecommunication networks		N/A
6.2.1	Separation requirements		N/A
6.2.2	Electric strength test procedure		N/A
6.2.2.1	Impulse test	(see appended table 5.2)	N/A
6.2.2.2	Steady-state test	(see appended table 5.2)	N/A

IEC 60950-1			
Clause	Requirement + Test	Result - Remark	Verdict
6.2.2.3	Compliance criteria		N/A
6.3	Protection of the telecommunication wiring system from overheating		N/A
	Max. Output current (A)		—
	Current limiting method		—
7	CONNECTION TO CABLE DISTRIBUTION SYSTEMS	<i>No such system</i>	N/A
7.1	General		N/A
7.2	Protection of cable distribution system service persons, and users of other equipment connected to the system, from hazardous voltages in the equipment		N/A
7.3	Protection of equipment users from overvoltages on the cable distribution system		N/A
7.4	Insulation between primary circuits and cable distribution systems		N/A
7.4.1	General		N/A
7.4.2	Voltage surge test	(see appended table 5.2)	N/A
7.4.3	Impulse test	(see appended table 5.2)	N/A

IEC 60950-1			
Clause	Requirement + Test	Result - Remark	Verdict
A	ANNEX A, TESTS FOR RESISTANCE TO HEAT AND FIRE <i>UL Recognized material used</i>		P
A.1	Flammability test for fire enclosures of movable equipment having a total mass exceeding 18 kg, and of stationary equipment (see 4.7.3.2)		N/A
A.1.1	Samples.....:		—
	Wall thickness (mm)		—
A.1.2	Conditioning of samples; temperature (°C)		N/A
A.1.3	Mounting of samples		N/A
A.1.4	Test flame (see IEC 60695-11-3)		N/A
	Flame A, B, C or D		—
A.1.5	Test procedure		N/A
A.1.6	Compliance criteria		N/A
	Sample 1 burning time (s)		—
	Sample 2 burning time (s)		—
	Sample 3 burning time (s)		—
A.2	Flammability test for fire enclosures of movable equipment having a total mass not exceeding 18 kg, and for material and components located inside fire enclosures (see 4.7.3.2 and 4.7.3.4)		P
A.2.1	Samples, material.....:		—
	Wall thickness (mm)		—
A.2.2	Conditioning of samples; temperature (°C) ..		N/A
A.2.3	Mounting of samples		N/A
A.2.4	Test flame (see IEC 60695-11-4)		N/A
	Flame A, B or C		—
A.2.5	Test procedure		N/A
A.2.6	Compliance criteria		N/A
	Sample 1 burning time (s)		—
	Sample 2 burning time (s)		—
	Sample 3 burning time (s)		—
A.2.7	Alternative test acc. To IEC 60695-11-5, cl. 5 and 9		N/A
	Sample 1 burning time (s)		—
	Sample 2 burning time (s)		—
	Sample 3 burning time (s)		—
A.3	Hot flaming oil test (see 4.6.2)		N/A

IEC 60950-1			
Clause	Requirement + Test	Result - Remark	Verdict
A.3.1	Mounting of samples		N/A
A.3.2	Test procedure		N/A
A.3.3	Compliance criterion		N/A

B	ANNEX B, MOTOR TESTS UNDER ABNORMAL CONDITIONS (see 4.7.2.2 and 5.3.2)		N/A
		<i>No motor used.</i>	
B.1	General requirements		N/A
	Position		—
	Manufacturer		—
	Type		—
	Rated values		—
B.2	Test conditions		N/A
B.3	Maximum temperatures		N/A
B.4	Running overload test		N/A
B.5	Locked-rotor overload test		N/A
	Test duration (days)		—
	Electric strength test: test voltage (V)		—
B.6	Running overload test for d.c. motors in secondary circuits		N/A
B.6.1	General		N/A
B.6.2	Test procedure		N/A
B.6.3	Alternative test procedure		N/A
B.6.4	Electric strength test; test voltage (V)		N/A
B.7	Locked-rotor overload test for d.c. motors in secondary circuits		N/A
B.7.1	General		N/A
B.7.2	Test procedure		N/A
B.7.3	Alternative test procedure		N/A
B.7.4	Electric strength test; test voltage (V)		N/A
B.8	Test for motors with capacitors	(see appended table 5.3)	N/A
B.9	Test for three-phase motors	(see appended table 5.3)	N/A
B.10	Test for series motors		N/A
	Operating voltage (V)		—

IEC 60950-1			
Clause	Requirement + Test	Result - Remark	Verdict
C	ANNEX C, TRANSFORMERS (see 1.5.4 and 5.3.3)		P
	Position	PT1	—
	Manufacturer	See table 1.5.1	—
	Type	See table 1.5.1	—
	Rated values	See table 1.5.1	—
	Method of protection	By protection circuit	—
C.1	Overload test	(see appended table 5.3)	P
C.2	Insulation	(see appended tables 5.2 and C2)	P
	Protection from displacement of windings.....	By bobbin and insulation tape	P
D	ANNEX D, MEASURING INSTRUMENTS FOR TOUCH-CURRENT TESTS (see 5.1.4)		P
D.1	Measuring instrument		P
D.2	Alternative measuring instrument		N/A
E	ANNEX E, TEMPERATURE RISE OF A WINDING (see 1.4.13)		N/A
F	ANNEX F, MEASUREMENT OF CLEARANCES AND CREEPAGE DISTANCES (see 2.10 and Annex G)		P
G	ANNEX G, ALTERNATIVE METHOD FOR DETERMINING MINIMUM CLEARANCES		N/A
G.1	Clearances		N/A
G.1.1	General		N/A
G.1.2	Summary of the procedure for determining minimum clearances		N/A
G.2	Determination of mains transient voltage (V)		N/A
G.2.1	AC mains supply		N/A
G.2.2	Earthed d.c. mains supplies		N/A
G.2.3	Unearthed d.c. mains supplies		N/A
G.2.4	Battery operation		N/A
G.3	Determination of telecommunication network transient voltage (V)		N/A
G.4	Determination of required withstand voltage (V)		N/A
G.4.1	Mains transients and internal repetitive peaks		N/A

IEC 60950-1			
Clause	Requirement + Test	Result - Remark	Verdict
G.4.2	Transients from telecommunication networks		N/A
G.4.3	Combination of transients		N/A
G.4.4	Transients from cable distribution systems		N/A
G.5	Measurement of transient voltages (V)		N/A
	a) Transients from a mains supply		N/A
	For an a.c. mains supply		N/A
	For a d.c. mains supply		N/A
	b) Transients from a telecommunication network		N/A
G.6	Determination of minimum clearances		N/A
H	ANNEX H, IONIZING RADIATION (see 4.3.13)		N/A
J	ANNEX J, TABLE OF ELECTROCHEMICAL POTENTIALS (see 2.6.5.6)		N/A
	Metal(s) used		—
K	ANNEX K, THERMAL CONTROLS (see 1.5.3 and 5.3.8)		N/A
K.1	Making and breaking capacity		N/A
K.2	Thermostat reliability; operating voltage (V)		N/A
K.3	Thermostat endurance test; operating voltage (V)		N/A
K.4	Temperature limiter endurance; operating voltage (V)		N/A
K.5	Thermal cut-out reliability		N/A
K.6	Stability of operation		N/A
L	ANNEX L, NORMAL LOAD CONDITIONS FOR SOME TYPES OF ELECTRICAL BUSINESS EQUIPMENT (see 1.2.2.1 and 4.5.2)		P
L.1	Typewriters		N/A
L.2	Adding machines and cash registers		N/A
L.3	Erasers		N/A
L.4	Pencil sharpeners		N/A
L.5	Duplicators and copy machines		N/A
L.6	Motor-operated files		N/A
L.7	Other business equipment	See 1.6.2	P

IEC 60950-1			
Clause	Requirement + Test	Result - Remark	Verdict
M	ANNEX M, CRITERIA FOR TELEPHONE RINGING SIGNALS (see 2.3.1)		N/A
M.1	Introduction		N/A
M.2	Method A		N/A
M.3	Method B		N/A
M.3.1	Ringling signal		N/A
M.3.1.1	Frequency (Hz)		—
M.3.1.2	Voltage (V)		—
M.3.1.3	Cadence; time (s), voltage (V)		—
M.3.1.4	Single fault current (Ma)		—
M.3.2	Tripping device and monitoring voltage		N/A
M.3.2.1	Conditions for use of a tripping device or a monitoring voltage		N/A
M.3.2.2	Tripping device		N/A
M.3.2.3	Monitoring voltage (V)		N/A
N	ANNEX N, IMPULSE TEST GENERATORS (see 1.5.7.2, 1.5.7.3, 2.10.3.9, 6.2.2.1, 7.3.2, 7.4.3 and Clause G.5)		N/A
N.1	ITU-T impulse test generators		N/A
N.2	IEC 60065 impulse test generator		N/A
P	ANNEX P, NORMATIVE REFERENCES		—
Q	ANNEX Q, Voltage dependent resistors (VDRs) (see 1.5.9.1)		N/A
	a) Preferred climatic categories	No VDRs used	N/A
	b) Maximum continuous voltage		N/A
	c) Pulse current		N/A
R	ANNEX R, EXAMPLES OF REQUIREMENTS FOR QUALITY CONTROL PROGRAMMES		N/A
R.1	Minimum separation distances for unpopulated coated printed boards (see 2.10.6.2)		N/A
R.2	Reduced clearances (see 2.10.3)		N/A
S	ANNEX S, PROCEDURE FOR IMPULSE TESTING (see 6.2.2.3)		N/A
S.1	Test equipment		N/A
S.2	Test procedure		N/A

IEC 60950-1			
Clause	Requirement + Test	Result - Remark	Verdict
S.3	Examples of waveforms during impulse testing		N/A
T	ANNEX T, GUIDANCE ON PROTECTION AGAINST INGRESS OF WATER (see 1.1.2)		N/A
			—
U	ANNEX U, INSULATED WINDING WIRES FOR USE WITHOUT INTERLEAVED INSULATION (see 2.10.5.4)		P
		VDE approved triple insulated wire used.	—
V	ANNEX V, AC POWER DISTRIBUTION SYSTEMS (see 1.6.1)		P
V.1	Introduction		P
V.2	TN power distribution systems		P
W	ANNEX W, SUMMATION OF TOUCH CURRENTS		N/A
W.1	Touch current from electronic circuits		N/A
W.1.1	Floating circuits		N/A
W.1.2	Earthed circuits		N/A
W.2	Interconnection of several equipments		N/A
W.2.1	Isolation		N/A
W.2.2	Common return, isolated from earth		N/A
W.2.3	Common return, connected to protective earth		N/A
X	ANNEX X, MAXIMUM HEATING EFFECT IN TRANSFORMER TESTS (see clause C.1)		N/A
X.1	Determination of maximum input current		N/A
X.2	Overload test procedure		N/A
Y	ANNEX Y, ULTRAVIOLET LIGHT CONDITIONING TEST (see 4.3.13.3)		N/A
Y.1	Test apparatus		N/A
Y.2	Mounting of test samples		N/A
Y.3	Carbon-arc light-exposure apparatus		N/A
Y.4	Xenon-arc light exposure apparatus		N/A
Z	ANNEX Z, OVERVOLTAGE CATEGORIES (see 2.10.3.2 and Clause G.2)		P

IEC 60950-1			
Clause	Requirement + Test	Result - Remark	Verdict
AA	ANNEX AA, MANDREL TEST (see 2.10.5.8)		N/A
BB	ANNEX BB, CHANGES IN THE SECOND EDITION		—
CC	ANNEX CC, Evaluation of integrated circuit (IC) current limiters		N/A
CC.1	General		N/A
CC.2	Test program 1.....:		N/A
CC.3	Test program 2.....:		N/A
DD	ANNEX DD, Requirements for the mounting means of rack-mounted equipment		N/A
DD.1	General		N/A
DD.2	Mechanical strength test, variable N.....:		N/A
DD.3	Mechanical strength test, 250N, including end stops.....:		N/A
DD.4	Compliance.....:		N/A
EE	ANNEX EE, Household and home/office document/media shredders		N/A
EE.1	General		N/A
EE.2	Markings and instructions		N/A
	Use of markings or symbols.....:		N/A
	Information of user instructions, maintenance and/or servicing instructions.....:		N/A
EE.3	Inadvertent reactivation test.....:		N/A
EE.4	Disconnection of power to hazardous moving parts:		N/A
	Use of markings or symbols.....:		N/A
EE.5	Protection against hazardous moving parts		N/A
	Test with test finger (Figure 2A)		N/A
	Test with wedge probe (Figure EE1 and EE2)		N/A

1.5.1	TABLE: List of critical components					P
Object/part No.	ManuFacterer/ trademark	Type/model	Technical data	Standard (Edition / year)	Mark(s) of conformity ¹⁾	
Inlet	Zhe Jiang Bei Er Jia Electronic Co., Ltd.	ST-A03-005	AC 2.5A, 250V	IEC/EN 60320-1	VDE 40014833	
Alternative	Rich Bay Co., Ltd.	R-201SN90	AC 2.5A, 250V	IEC/EN 60320-1	VDE 40030384	
Fuse (CF1)	Walter Electronic Co. Ltd. Conquer Electronics Co., Ltd.	PDU series	AC 250V, T3.15A	IEC/EN 60127-1 IEC/EN 60127-3	VDE 40006776	
Alternative	Shenzhen Lanson Electronics Co. Ltd.	3K T3,15A250V	AC 250V, T3.15A	IEC/EN 60127-1 IEC/EN 60127-3	VDE 40010682	
X2-cap C1	Xiamen Faratronic Co. Ltd.	MKP62	0.1µF, 275Vac, X2, 110°C	IEC/EN 60384-14	VDE 40000358	
Alternative	Carli Electronics Co., Ltd.	MPX	0.1µF, 275Vac, X2, 100°C	IEC/EN 60384-14	VDE 40008520	
Alternative	Tenta Electric Industrial Co. Ltd.	MEX	0.1µF, 275Vac, X2, 100°C	IEC/EN 60384-14	VDE 119119	
Y1-cap C9	Success Electronics Co., Ltd.	SE	2200pF, 250Vac, Y1, 125°C	IEC/EN 60384-14	VDE 126596	
Alternative	JAY-NAY Co., Ltd.	JN	2200pF, 250Vac, Y1, 125°C	IEC/EN 60384-14	VDE 40001831	
Alternative	Hsuan Tai Electronic Co. Ltd.	CY	2200pF, 400Vac, Y1, 105°C	IEC/EN 60384-14	VDE 40008912	
Optocoupler (IC2)	Everlight Electronics Co., Ltd.	EL817	Isolation Voltage=850V Peak Transient Over voltage = 6000V, CTI 175, internal Cr.=6.0mm, external Cr.=7.7mm, Dti=0.5mm	IEC/EN 60747-5-2 IEC/EN 60950-1	VDE 132249	

Alternative	VISHAY Semiconductor GmbH	TCET1114G	Isolation Voltage=850V Peak Transient Over voltage = 8000V, CTI 175, internal Cr.=4.3mm, external Cr.=8.1mm, Dti=0.7mm	IEC/EN 60747-5- 2 IEC/EN 60950-1	VDE 40028080
Alternative	COSMO Electronics Corporation	KPC817	Isolation Voltage=850V Peak Transient Over voltage = 8000V, CTI 175, internal Cr.=5.3mm, external Cr.=8.0mm, Dti=0.5mm	IEC/EN 60747-5- 2 IEC/EN 60950-1	VDE 101347
PCB	Various	Various	V-0, 130°C	UL 94	UL
Enclosure	SABIC INNOVATIVE PLASTICS US L L C	920(f1)/923(f1)	V-0, 130°C Thickness 2.4mm	UL 94	E121562
Alternative	TEIJIN CHEMICALS LTD	LN-1250G	V-0, 105°C Thickness 2.4mm	UL 94	UL E50075
Transformer (PT1)	Fuyuan Electronic Co.,Ltd	FYxxxxyyy PT	Class B	--	Test in appliance
Bobbin of PT1 and L1	CHANG CHUN PLASTICS CO LTD	T375J	V-0, 150°C	UL 94	UL E59481
Insulating Tape of PT1 and L1	JINGJIANG YAHUA PRESSURE SENSITIVE GLUE CO LTD	PZ	130°C	UL 510	UL E165111
Triple insulated wire of PT1	GREAT LEOFON INDUSTRIAL CO LTD	TRW (F)	155°C, 600V	IEC/EN 60950-1	VDE 136581
Magnet wire of PT1 and L1	XIN LONG MAGNET WIRE CO LTD	UEW	130°C	UL 1446	UL E171082
Line Filter (L1)	Fuyuan Electronic Co.,Ltd	FY120L1	130°C	--	Test in appliance
Shrinkable tubing	DONGGUAN QUANTAI ELECTRONICS CO LTD	T-2	125°C, 600V	UL224	UL E227336

Alternative	CHANGYUAN ELECTRONICS (SHENZHEN)	CB-HFT	125°C, 600V	UL224	UL E180908
Alternative	UNICHEM CO LTD	KUHS-225	125°C, 600V	UL224	UL E157822
D1-D4	--	--	Min. 3A, 800V	--	--
Ripple Cap. (C2)	Various	--	Min. 150µF, 400V, 105°C	--	--
Output cable	Various	Various	105°C, 300V, 18 AWG, VW-1	UL	UL
Note: ¹⁾ An asterisk indicates a mark which assures the agreed level of surveillance					

1.6.2		TABLE: Electrical data (in normal conditions)					P
U (V/Hz)	I (mA)	Irated (A)	P (W)	Fuse #	Ifuse (mA)	Condition/status	
For model FY1267500							
90V/50Hz	1887	--	108.2	CF1	1887	12.6V/7500mA	
90V/60Hz	1846	--	105.6	CF1	1846		
100V/50Hz	1698	2.5	107.6	CF1	1698		
100V/60Hz	1656	2.5	105.0	CF1	1656		
240V/50Hz	947	2.5	107.2	CF1	947		
240V/60Hz	912	2.5	110.6	CF1	912		
254.4V/50Hz	912	--	110.8	CF1	912		
254.4V/60Hz	862	--	110.8	CF1	862		
For model FY2405000							
90V/50Hz	2420	--	133.0	CF1	2420	24.0V/5000mA	
90V/60Hz	2250	--	132.8	CF1	2250		
100V/50Hz	2090	0.3	132.7	CF1	2090		
100V/60Hz	1991	0.3	131.8	CF1	1991		
240V/50Hz	1150	0.3	129.2	CF1	1150		
240V/60Hz	1125	0.3	131.1	CF1	1125		
254.4V/50Hz	1056	--	130.6	CF1	1056		
254.4V/60Hz	1058	--	133.0	CF1	1058		
For model FY4802500							
90V/50Hz	2300	--	129.5	CF1	2300	48.0V/2500mA	
90V/60Hz	2160	--	128.5	CF1	2160		
100V/50Hz	2020	0.3	127.8	CF1	2020		
100V/60Hz	1942	0.3	128.1	CF1	1942		
240V/50Hz	1125	0.3	127.8	CF1	1125		

240V/60Hz	1035	0.3	127.2	CF1	1035	
254.4V/50Hz	1027	--	124.4	CF1	1027	
254.4V/60Hz	1020	--	126.7	CF1	1020	
For model FY5802000						
90V/50Hz	2340	--	130.4	CF1	2340	58.0V/2000mA
90V/60Hz	2170	--	129.1	CF1	2170	
100V/50Hz	2020	0.3	127.6	CF1	2020	
100V/60Hz	1943	0.3	128.1	CF1	1943	
240V/50Hz	1102	0.3	126.7	CF1	1102	
240V/60Hz	1107	0.3	129.0	CF1	1107	
254.4V/50Hz	1042	--	124.0	CF1	1042	
254.4V/60Hz	1019	--	127.9	CF1	1019	
For model FY0307500						
90V/50Hz	595	--	32.8	CF1	595	3.0V/7500mA
90V/60Hz	578	--	30.6	CF1	578	
100V/50Hz	544	0.3	34.2	CF1	544	
100V/60Hz	524	0.3	31.1	CF1	524	
240V/50Hz	323	0.3	36.3	CF1	323	
240V/60Hz	295	0.3	34.7	CF1	295	
254.4V/50Hz	293	--	37.4	CF1	293	
254.4V/60Hz	291	--	35.2	CF1	291	
For model FY1207500						
90V/50Hz	1195	--	104.8	CF1	1195	12.0V/7500mA
90V/60Hz	1821	--	104.7	CF1	1821	
100V/50Hz	1693	2.5	104.1	CF1	1693	
100V/60Hz	1620	2.5	103.9	CF1	1620	
240V/50Hz	923	2.5	106.1	CF1	923	
240V/60Hz	892	2.5	104.1	CF1	892	
254.4V/50Hz	836	--	108.8	CF1	836	
254.4V/60Hz	885	--	106.3	CF1	885	
supplementary information:						

2.1.1.5 c) 1) TABLE: max. V, A, VA test					P
Voltage (rated) (V)	Current (rated) (A)	Voltage (max.) (V)	Current (max.) (A)	VA (max.) (VA)	
FY1267500					

12.6	7.5	12.12	15.14	140.9
FY2405000				
24	5.0	23.8	5.07	118.3
FY4802500				
48	2.5	46.3	2.73	124.2
FY5802000				
58	2.0	58.5	2.05	117.6
FY0307500				
3	7.5	3.27	9.45	21.2
FY1207500				
12	7.5	12.1	8.98	106.8
supplementary information:				
Note: the output energy less than 240VA.				

2.1.1.7	TABLE: discharge test				N/A
Condition	τ calculated (s)	τ measured (ms)	t u→ 0V (s)	Comments	
Notes:					

2.2	TABLE: evaluation of voltage limiting components in SELV circuits				P
Component (measured between)	max. voltage (V) (normal operation)		Voltage Limiting Components		
	V peak	V d.c.			
For model FY1267500					
PT1 Pin 9 to pin 10	52.0	--	--		
	--	14.4	After D8		
For model FY2405000					
PT1 Pin 9 to pin 10	68.0	-	--		
	-	27.7	After D8		
For model FY4802500					
PT1 Pin 9 to pin 10	132.0	-	--		
	-	44.5	After D8		
For model FY5802000					
PT1 Pin 9 to pin 10	136.0	-	--		

	-	58.2	After D8
Note: Unit shutdown. Supplied at 240V/60Hz.			

2.4.2	TABLE: limited current circuit measurement					P
Location	Voltage (V)	Current (mA)	Freq. (kHz)	Limit (mA)	Comments	
FY1267500						
Y1-cap (C9)	6.2	3.1	56	39.2	A 2 kΩ resistor's one terminal connected to secondary pin of C9, the other terminal of which was directly connected to neutral.	
FY2405000						
Y1-cap (C9)	6.2	3.1	56	39.2	A 2 kΩ resistor's one terminal connected to secondary pin of C9, the other terminal of which was directly connected to neutral.	
FY4802500						
Y1-cap (C9)	6.2	3.1	56	39.2	A 2 kΩ resistor's one terminal connected to secondary pin of C9, the other terminal of which was directly connected to neutral.	
FY5802000						
Y1-cap (C9)	5.6	2.8	56	39.2	A 2 kΩ resistor's one terminal connected to secondary pin of C9, the other terminal of which was directly connected to neutral.	
Note(s):						

2.5	TABLE: limited power source measurement (<i>Not required</i>)			N/A
	Limits		Measured	Verdict
According to Table 2B (normal condition)				
current (in A)				
apparent power (in VA)				
Note(s):				

2.6.3.4	TABLE: ground continue test		N/A
Location	Resistance measured (mΩ)	Comments	

--	--	--

2.10.2	Table: working voltage measurement			P
Location	RMS voltage (V)	Peak voltage (V)	Comments	
For model FY1267500				
Pin 1-9 of PT1	256	472	The highest rms and Vpeak	
Pin 1-10 of PT1	243	440		
Pin 2-9 of PT1	-	-		
Pin 2-10 of PT1	-	-		
Pin 3-9 of PT1	208	344		
Pin 3-10 of PT1	203	384		
Pin 4-9 of PT1	252	408		
Pin 4-10 of PT1	241	368		
Pin 5-9 of PT1	239	360		
Pin 5-10 of PT1	226	384		
Note (S): Supply 240V/50Hz, normal load: 12.6V/7500mA				
For model FY2405000				
Pin 1-9 of PT1	269	512	The highest rms and Vpeak	
Pin 1-10 of PT1	267	480		
Pin 2-9 of PT1	-	-		
Pin 2-10 of PT1	-	-		
Pin 3-9 of PT1	207	344		
Pin 3-10 of PT1	210	408		
Pin 4-9 of PT1	235	400		
Pin 4-10 of PT1	250	384		
Pin 5-9 of PT1	234	376		
Pin 5-10 of PT1	235	400		
Note (S): Supply 240V/50Hz, normal load: 24.0V/5000mA				
For model FY4802500				
Pin 1-9 of PT1	263	472	The highest rms and Vpeak	
Pin 1-10 of PT1	239	424		
Pin 2-9 of PT1	-	-		
Pin 2-10 of PT1	-	-		
Pin 3-9 of PT1	227	352		
Pin 3-10 of PT1	215	464		

Pin 4-9 of PT1	247	408	
Pin 4-10 of PT1	223	400	
Pin 5-9 of PT1	250	368	
Pin 5-10 of PT1	230	416	
Note (S): Supply 240V/50Hz, normal load: 48.0V/2500mA			
For model FY5802000			
Pin 1-9 of PT1	272	512	The highest rms and Vpeak
Pin 1-10 of PT1	239	440	
Pin 2-9 of PT1	-	-	
Pin 2-10 of PT1	-	-	
Pin 3-9 of PT1	205	352	
Pin 3-10 of PT1	220	472	
Pin 4-9 of PT1	240	400	
Pin 4-10 of PT1	209	424	
Pin 5-9 of PT1	241	384	
Pin 5-10 of PT1	227	440	
Note (S): Supply 240V/50Hz, normal load: 58.0V/2000mA			

2.10.3 and 2.10.4	TABLE: clearance and creepage distance measurements					P
Clearance cl and creepage distance dcr at/of:	Up (V)	U r.m.s. (V)	Required cl (mm)	cl (mm)	Required dcr (mm)	dcr (mm)
On primary						
L-N on PCB (F)*	420	240	1.5	6.1	2.5	6.1
Different polarity of fuse F1 (F)	420	240	1.5	3.0	2.5	3.0
Primary components to accessible part						
Heat sink on primary (with 10N) to enclosure outside (R)*	420	240	4.0	8.6	5.0	8.6
Primary components to secondary components						
Primary to secondary of Opto-coupler IC2 (R)	512	272	4.4	6.2	5.8	6.2
Primary to secondary of Y1-cap C9 (R)	512	272	4.4	6.2	5.8	6.2
Pri. trace to fixing point of Sec. heat sink on PCB (R)	512	272	4.4	6.2	5.8	6.2
Primary to secondary of transformer (R)	512	272	4.4	6.2	5.8	6.2

Secondary to core of transformer (R)	512	272	4.4	6.2	5.8	6.2
<p>Note(s): The construction check performed on the transformer of model FY5802000 which has the total Max. Secondary windings diameter considering the turns.</p> <p>* F=functional insulation, R=reinforced insulation.</p> <p>1) 3 layers insulation tape wrapped between primary soldering points, components and secondary heat sink as reinforced insulation</p> <p>2) 3 layers insulation tape wrapped between secondary soldering points, components and primary heat sink as reinforced insulation</p> <p>3) 3 layers insulation tape wrapped around external of transformer as reinforced insulation</p> <p>4) Heat shrinkable tube used on fuse CF1 and C9 as functional insulation.</p> <p>5) Triple insulated wire used for secondary winding of the transformer.</p>						

2.10.5	TABLE: Distance through insulation measurements					P
Distance through insulation (DTI) at/of:	U peak (V)	U rms (V)	Test voltage(V)	Required DTI(mm)	DTI (mm)	
Opto-coupler (for reinforced insulation)	420	250	AC 3000	0.4	0.5	
Enclosure (for reinforced insulation)	420	250	AC 3000	0.4	2.4	
Note(s):-						

4.5.1	TABLE: maximum temperatures				P	
	test voltage (V)	100x0.9=90V / 240x1,06=254V			—	
	t _{amb1} (°C)	See below			—	
	t _{amb2} (°C)	See below			—	
maximum temperature T of part/at::		T (°C)			allowed T _{max} (°C)	
		90V/50Hz		254V/50Hz		
		Label up	Label down	Label up	Label down	
For model FY1267500						
Ambient		25.0	25.0	25.0	25.0	--
AC inlet		56.2	55.3	43.2	46.0	70
X2-cap C1 body		69.9	68.1	53.6	55.2	100
L1 winding		84.9	84.4	62.7	64.0	130
PCB near D1		58.7	60.5	46.8	46.0	130
C2 body		86.7	85.6	65.3	66.8	105
Primary heatsink		74.9	72.5	63.5	65.7	--
Secondary heatsink		90.3	91.3	76.1	75.3	--
PT1 winding		87.0	86.5	83.1	86.8	120- 10=110
PT1 core		88.2	86.9	81.4	82.5	120- 10=110
Y1-cap C9 body		76.7	74.0	66.1	69.2	105
Opto-coupler IC2 body		74.8	77.3	64.3	61.1	100
PCB near R3		78.2	77.9	67.4	69.8	130
Output wire		68.0	68.8	58.5	55.2	105
Enclosure above PT1(inside)		79.2	80.8	68.8	71.1	105
Enclosure above PT1(outside)		66.4	64.6	57.3	55.2	95
Enclosure under PT1(outside)		81.3	82.2	59.6	61.1	95
Enclosure under PT1(inside)		71.0	72.5	66.0	67.6	105
For model FY2405000						
Ambient		25.0	25.0	25.0	25.0	--
AC inlet		67.7	64.5	42.3	46.0	70
X2-cap C1 body		84.2	82.8	57.7	56.4	100
L1 winding		86.2	88.8	69.4	67.1	130
PCB near D1		90.6	93.3	65.8	64.3	130
C2 body		86.6	86.6	60.6	59.3	105

Primary heatsink	84.7	82.8	63.3	60.5	--
Secondary heatsink	86.4	87.8	96.5	95.3	--
PT1 winding	79.6	81.0	86.9	84.5	120-10=110
PT1 core	77.4	78.8	84.4	85.6	120-10=110
Y1-cap C9 body	74.9	76.3	71.0	71.2	105
Opto-coupler IC2 body	76.8	75.1	65.9	68.1	100
PCB near R3	84.0	86.9	67.8	66.9	130
Output wire	65.1	63.0	79.4	77.5	105
Enclosure above PT1 (inside)	72.6	70.1	74.0	73.3	105
Enclosure above PT1(outside)	64.9	64.5	65.9	65.4	95
Enclosure under PT1(outside)	71.6	70.3	72.6	70.5	95
Enclosure under PT1(inside)	75.1	78.3	74.6	75.4	105
For model FY4802500					
Ambient	25.0	25.0	25.0	25.0	--
AC inlet	51.8	50.6	42.2	46.0	70
X2-cap C1 body	63.6	65.4	53.4	54.2	100
L1 winding	76.9	77.0	63.4	60.5	130
PCB near D1	84.6	82.6	64.1	66.9	130
C2 body	86.1	88.3	67.2	68.1	105
Primary heatsink	74.0	75.9	63.4	65.3	--
Secondary heatsink	69.9	71.0	66.3	65.4	--
PT1 winding	85.6	85.6	84.4	86.8	120-10=110
PT1 core	81.2	81.0	82.9	85.6	120-10=110
Y1-cap C9 body	71.5	69.9	66.9	70.0	105
Opto-coupler IC2 body	68.7	71.2	63.8	64.3	100
PCB near R3	76.3	77.5	67.7	69.9	130
Output wire	49.5	46.0	44.7	43.0	105
Enclosure above PT1(inside)	55.4	54.5	55.5	56.4	105
Enclosure above PT1(outside)	53.8	56.4	53.6	50.6	95
Enclosure under PT1(outside)	66.7	67.1	65.0	67.1	95
Enclosure under PT1(inside)	73.0	75.4	73.0	72.8	105
For model FY5802000					
Ambient	25.0	25.0	25.0	25.0	--

AC inlet	65.5	62.3	54.0	59.3	70
X2-cap C1 body	80.1	80.8	41.9	41.1	100
L1 winding	55.2	52.8	52.3	54.2	130
PCB near D1	85.9	86.9	62.5	62.0	130
C2 body	85.5	85.6	48.3	48.9	105
Primary heatsink	67.6	64.6	63.9	63.1	--
Secondary heatsink	85.6	88.3	69.1	69.1	--
PT1 winding	81.6	81.1	83.0	85.5	120-10=110
PT1 core	72.7	77.9	76.2	76.8	120-10=110
Y1-cap C9 body	71.9	74.9	84.5	85.7	105
Opto-coupler IC2 body	79.4	82.2	69.2	66.9	100
PCB near R3	56.6	52.8	62.7	62.1	130
Output wire	63.9	62.3	64.2	64.5	105
Enclosure above PT1(inside)	66.7	68.0	70.1	70.4	105
Enclosure above PT1(outside)	60.8	64.9	62.4	60.7	95
Enclosure under PT1(outside)	70.7	66.5	71.2	71.6	95
Enclosure under PT1(inside)	71.2	73.7	76.4	75.5	105

4.5.5	TABLE: Ball pressure test of thermoplastic parts			N/A
	Allowed impression diameter (mm)	≤ 2 mm		—
Part		Test temperature (°C)	Impression diameter (mm)	
Note(s): --				

4.7	TABLE: Resistance to fire					P
Part	Manufacturer of material	Type of material	Thickness (mm)	Flammability class	Evidence	
Supplementary information: See table 1.5.1						

5.1	TABLE: touch current measurement			P
Measured between:	Measured (mA)	Limit (mA)	Comments/conditions	
L → Output terminal	0.15	0.25	--	
N → Output terminal	0.15	0.25	--	
L → plastic enclosure	0.005	0.25	--	

N → plastic enclosure	0.005	0.25	--
supplementary information:			
Supplied with 254.4V/60Hz.			

5.2	TABLE: Electric strength tests, impulse tests and voltage surge tests			P
Test voltage applied between:	Voltage shape (AC, DC, impulse, surge)	Test voltage (V)	Breakdown Yes / No	
L to N after fuse disconnection	AC	1500	No	
L/N and accessible parts	AC	3000	No	
Primary to secondary of transformer	AC	3000	No	
Secondary to core of transformer	AC	3000	No	
Two layers of 3 layers insulation tape wrapped between primary soldering points, components and secondary heat sink	AC	3000	No	
Two layers of 3 layers insulation tape wrapped around external of transformer	AC	3000	No	
Note(s): The test performed immediately following the heating test as specified according to 4.5.1, 2.9.2 and 5.3 except the last 2 items.				

5.3	TABLE: Fault condition tests					P
	Ambient temperature (°C).....:		25		—	
	Power source for EUT: ManuFacterer, model/type, output rating		--		—	
Component No.	Fault	Supply voltage (V)	Test time	Fuse #	Fuse current (A)	Observation
For model FY1267500						
Output	S-C	240V	1 minute	CF1	0.95→0.18	The unit shutdown immediately, recoverable after the fault removed, no hazards observed.
Output	O-L	240V	240 minutes	CF1	0.95→1.18	After the overload applied for 240 minutes, the unit shutdown at the max. output current 9.45A, the max. temperature of primary winding is 105.2°C. No hazards. Limit: (175-10)°C=165°C
D1	S-C	240V	1 second	CF1	0.95→0	Fuse opened immediately, no hazards observed.
R3	S-C	240V	10 minutes	CF1	0.95→0.95	The unit normally operation, no hazards observed.

C2	S-C	240V	10 minutes	CF1	0.95→0.95	The unit normally operation, no hazards observed.
R2	S-C	240V	1 second	CF1	0.95→0	Fuse opened immediately, no hazards observed.
D7	S-C	240V	10 minutes	CF1	0.95→0.95	The unit normally operation, no hazards observed.
D8	S-C	240V	1 second	CF1	0.95→0	Fuse opened immediately, no hazards observed.
Pin9 to Pin10 of PT1	S-C	240V	1 second	CF1	0.95→0	Fuse opened immediately, R6, T1 damaged, no hazards observed.
IC2 Primary	O-C	240V	10 minutes	CF1	0.95→0	The unit shutdown immediately, recoverable after the fault removed, no hazards observed.
IC2 Secondary	S-C	240V	1 second	CF1	0.95→0	Fuse opened immediately, R6, T1 damaged, no hazards observed.
IC2 Primary	S-C	240V	10 minutes	CF1	0.95→0	The unit shutdown immediately, recoverable after the fault removed, no hazards observed.
IC2 Secondary	O-C	240V	35 minutes	CF1	0.95→1.98	After the short applied for 28 minutes, the unit shutdown, the max. temperature of primary winding is 115.6°C, Max. Output voltage is 12.5Vdc. R6, T1 damaged, CF1 opened, No hazards. Limit: (175-10)°C=165°C
Pin2-pin7 of IC1	S-C	240V	10 minutes	CF1	0.95→0	The unit shutdown immediately, recoverable after the fault removed, no hazards observed.
T1 G-S	S-C	240V	1 second	CF1	0.95→0	Fuse opened immediately, no hazards observed.
T1 G-D	S-C	240V	10 minutes	CF1	0.95→0	The unit shutdown immediately, recoverable after the fault removed, no hazards observed.
T1 D-S	S-C	240V	1 second	CF1	0.95→0	Fuse opened immediately, no hazards observed.

Transformer	O-L	240V	540 minutes	CF1	0.95→1.25	After the overload applied for 540 minutes, the unit shutdown at the max. output current 9.5A, the max. temperature of primary winding is 102.4°C. No hazards. Limit: (175-10)°C=165°C
For model FY2405000						
Output	S-C	240V	1 minute	CF1	1.15→0.13	The unit shutdown immediately, recoverable after the fault removed, no hazards observed.
Output	O-L	240V	240 minutes	CF1	1.15→1.21	After the overload applied for 240 minutes, the unit shutdown at the max. output current 5.2A, the max. temperature of primary winding is 101.5°C. No hazards. Limit: (175-10)°C=165°C
D1	S-C	240V	1 second	CF1	1.15→0	Fuse opened immediately, no hazards observed.
R3	S-C	240V	10 minutes	CF1	1.15→1.15	The unit normally operation, no hazards observed.
C2	S-C	240V	10 minutes	CF1	1.15→1.15	The unit normally operation, no hazards observed.
R2	S-C	240V	1 second	CF1	1.15→0	Fuse opened immediately, no hazards observed.
D7	S-C	240V	10 minutes	CF1	1.15→1.15	The unit normally operation, no hazards observed.
C5	S-C	240V	1 second	CF1	1.15→0	Fuse opened immediately, no hazards observed.
D8	S-C	240V	1 second	CF1	1.15→0	Fuse opened immediately, no hazards observed.
Pin9 to Pin10 of PT1	S-C	240V	1 second	CF1	1.15→0	Fuse opened immediately, R6, T1 damaged, no hazards observed.
IC2 Primary	O-C	240V	10 minutes	CF1	1.15→0	The unit shutdown immediately, recoverable after the fault removed, no hazards observed.
IC2 Secondary	S-C	240V	1 second	CF1	1.15→0	Fuse opened immediately, R6, T1 damaged, no hazards observed.

IC2 Primary	S-C	240V	10 minutes	CF1	1.15→0	The unit shutdown immediately, recoverable after the fault removed, no hazards observed.
IC2 Secondary	O-C	240V	35 minutes	CF1	1.15→2.04	After the short applied for 28 minutes, the unit shutdown, the max. temperature of primary winding is 122.6°C, Max. Output voltage is 23.8Vdc. R6, T1 damaged, CF1 opened, No hazards. Limit: (175-10)°C=165°C
Pin2-pin7 of IC1	S-C	240V	10 minutes	CF1	1.15→0	The unit shutdown immediately, recoverable after the fault removed, no hazards observed.
T1 G-S	S-C	240V	1 second	CF1	1.15→0	Fuse opened immediately, no hazards observed.
T1 G-D	S-C	240V	10 minutes	CF1	1.15→0	The unit shutdown immediately, recoverable after the fault removed, no hazards observed.
T1 D-S	S-C	240V	1 second	CF1	1.15→0	Fuse opened immediately, no hazards observed.
Transformer	O-L	240V	540 minutes	CF1	1.15→1.35	After the overload applied for 540 minutes, the unit shutdown at the max. output current 5.7A, the max. temperature of primary winding is 102.1°C. No hazards. Limit: (175-10)°C=165°C
For model FY4802500						
Output	S-C	240V	1 minute	CF1	1.13→0.12	The unit shutdown immediately, recoverable after the fault removed, no hazards observed.
Output	O-L	240V	240 minutes	CF1	1.13→1.18	After the overload applied for 240 minutes, the unit shutdown at the max. output current 2.7A, the max. temperature of primary winding is 101.5°C. No hazards. Limit: (175-10)°C=165°C
D1	S-C	240V	1 second	CF1	1.13→0	Fuse opened immediately, no hazards observed.
R3	S-C	240V	10 minutes	CF1	1.13→1.13	The unit normally operation, no hazards observed.

C2	S-C	240V	10 minutes	CF1	1.13→1.13	The unit normally operation, no hazards observed.
R2	S-C	240V	1 second	CF1	1.13→0	Fuse opened immediately, no hazards observed.
D7	S-C	240V	10 minutes	CF1	1.13→1.13	The unit normally operation, no hazards observed.
C5	S-C	240V	1 second	CF1	1.13→0	Fuse opened immediately, no hazards observed.
D8	S-C	240V	1 second	CF1	1.13→0	Fuse opened immediately, no hazards observed.
Pin9 to Pin10 of PT1	S-C	240V	1 second	CF1	1.13→0	Fuse opened immediately, R6, T1 damaged, no hazards observed.
IC2 Primary	O-C	240V	10 minutes	CF1	1.13→0	The unit shutdown immediately, recoverable after the fault removed, no hazards observed.
IC2 Secondary	S-C	240V	1 second	CF1	1.13→0	Fuse opened immediately, R6, T1 damaged, no hazards observed.
IC2 Primary	S-C	240V	10 minutes	CF1	1.13→0	The unit shutdown immediately, recoverable after the fault removed, no hazards observed.
IC2 Secondary	O-C	240V	35 minutes	CF1	1.13→2.05	After the short applied for 28 minutes, the unit shutdown, the max. temperature of primary winding is 125.6°C, Max. Output voltage is 48.3Vdc. R6, T1 damaged, CF1 opened, No hazards. Limit: (175-10)°C=165°C
Pin2-pin7 of IC1	S-C	240V	10 minutes	CF1	1.13→0	The unit shutdown immediately, recoverable after the fault removed, no hazards observed.
T1 G-S	S-C	240V	1 second	CF1	1.13→0	Fuse opened immediately, no hazards observed.
T1 G-D	S-C	240V	10 minutes	CF1	1.13→0	The unit shutdown immediately, recoverable after the fault removed, no hazards observed.
T1 D-S	S-C	240V	1 second	CF1	1.13→0	Fuse opened immediately, no hazards observed.

Transformer	O-L	240V	600 minutes	CF1	1.13→1.25	After the overload applied for 600 minutes, the unit shutdown at the max. output current 3.2A, the max. temperature of primary winding is 115.4°C. No hazards. Limit: (175-10)°C=165°C
For model FY5802000						
Output	S-C	240V	1 minute	CF1	1.10→0.09	The unit shutdown immediately, recoverable after the fault removed, no hazards observed.
Output	O-L	240V	240 minutes	CF1	1.10→1.18	After the overload applied for 240 minutes, the unit shutdown at the max. output current 2.2A, the max. temperature of primary winding is 112.4°C. No hazards. Limit: (175-10)°C=165°C
D1	S-C	240V	1 second	CF1	1.10→0	Fuse opened immediately, no hazards observed.
R3	S-C	240V	10 minutes	CF1	1.10→1.10	The unit normally operation, no hazards observed.
C2	S-C	240V	10 minutes	CF1	1.10→0.93	The unit normally operation, no hazards observed.
R2	S-C	240V	1 second	CF1	1.10→0	Fuse opened immediately, no hazards observed.
D7	S-C	240V	10 minutes	CF1	1.10→1.10	The unit normally operation, no hazards observed.
C5	S-C	240V	1 second	CF1	1.10→0	Fuse opened immediately, no hazards observed.
D8	S-C	240V	1 second	CF1	1.10→0	Fuse opened immediately, no hazards observed.
Pin9 to Pin10 of PT1	S-C	240V	1 second	CF1	1.10→0	Fuse opened immediately, R6, T1 damaged, no hazards observed.
IC2 Primary	O-C	240V	10 minutes	CF1	1.10→0	The unit shutdown immediately, recoverable after the fault removed, no hazards observed.
IC2 Secondary	S-C	240V	1 second	CF1	1.10→0	Fuse opened immediately, R6, T1 damaged, no hazards observed.

IC2 Primary	S-C	240V	10 minutes	CF1	1.10→0	The unit shutdown immediately, recoverable after the fault removed, no hazards observed.
IC2 Secondary	O-C	240V	35 minutes	CF1	1.10→2.14	After the short applied for 35 minutes, the unit shutdown, the max. temperature of primary winding is 122.4°C, Max. Output voltage is 58.2Vdc. R6, T1 damaged, CF1 opened, No hazards. Limit: (175-10)°C=165°C
Pin2-pin7 of IC1	S-C	240V	10 minutes	CF1	1.10→0	The unit shutdown immediately, recoverable after the fault removed, no hazards observed.
T1 G-S	S-C	240V	1 second	CF1	1.10→0	Fuse opened immediately, no hazards observed.
T1 G-D	S-C	240V	10 minutes	CF1	1.10→0	The unit shutdown immediately, recoverable after the fault removed, no hazards observed.
T1 D-S	S-C	240V	1 second	CF1	1.10→0	Fuse opened immediately, no hazards observed.
Transformer	O-L	240V	540 minutes	CF1	0.95→1.04	After the overload applied for 540 minutes, the unit shutdown at the max. output current 2.8A, the max. temperature of primary winding is 138.8°C. No hazards. Limit: (175-10)°C=165°C
Note (S): S-C=short-circuited, O-C=open-circuited, O-L=overload. The unit passed 3000V hi-pot test between primary and accessible parts after the above single fault condition performed.						

C.2	Safety isolation transformer	P
Construction details:		
Transformer PT1		
Mfr.: see table 1.5.1		
Type: see table 1.5.1		
Note: the construction check performed on the transformer of model FY5802000 which has the total Max. Secondary windings diameter considering the turns.		
Recurring peak voltage	512V	
Required clearance for reinforced insulation (from table 2K and 2L)	4.4mm	
Effective voltage rms	272V	
Required creepage for reinforced insulation (from table 2N)	5.6mm	
Measured min. creepages		
Location	inside (mm)	outside (mm)
prim-sec	Triple insulated wire used.	6.2
sec-core	Triple insulated wire used.	6.2
prim-prim	%	%
Measured min. clearances		
Location	inside (mm)	outside (mm)
prim-sec	Triple insulated wire used.	6.2
sec-core	Triple insulated wire used.	6.2
prim-prim	%	%
Construction:		
Core was considered as primary. Concentric windings on type T375J bobbin (Phenolic, thickness 0.8mm, V-0), three layers insulation tape wrapped around external of transformer as reinforced insulation. Triple insulated wires used as secondary winding. Insulating tape used to separate primary windings and secondary triple insulated wires in crossing section. The lead pins soldered to primary windings were directly moulded in bobbin and the lead pins of secondary windings were directly moulded in PCB.		
Pin numbers		
Prim.	1→3, 4→5	
Sec.	9→10	
Bobbin		
Material	See appended table 1.5.1	
Thickness	See appended table 1.5.1	

Electric strength test	
With AC 3000V after humidity treatment	
Result	Pass

National Differences			
Clause	Requirement + Test	Result - Remark	Verdict

ATTACHMENT TO TEST REPORT IEC 60950-1 EUROPEAN GROUP DIFFERENCES AND NATIONAL DIFFERENCES Information technology equipment – Safety – PART 1: GENERAL REQUIREMENTS			
Differences according to		EN 60950-1:2006/A11:2009/A1:2010/A12:2011	
Attachment Form No.		EU_GD_IEC60950_1C_II	
Attachment Originator		SGS Fimko Ltd	
Master Attachment		Date 2011-08	
Copyright © 2011 IEC System for Conformity Testing and Certification of Electrical Equipment (IECEE), Geneva, Switzerland. All rights reserved.			

EN 60950-1:2006/A11:2009/A1:2010/A12:2011 – CENELEC COMMON MODIFICATIONS

IEC 60950-1, GROUP DIFFERENCES (CENELEC common modifications EN)			
Clause	Requirement + Test	Result - Remark	Verdict
Contents	Add the following annexes: Annex ZA (normative) Normative references to international publications with their corresponding European publications Annex ZB (normative) Special national conditions		P
General	Delete all the “country” notes in the reference document (IEC 60950-1:2005) according to the following list: 1.4.8 Note 21.5.1 Note 2 & 3 1.5.7.1 Note 1.5.8 Note 2 1.5.9.4 Note 1.7.2.1 Note 4, 5 & 6 2.2.3 Note 2.2.4 Note 2.3.2 Note 2.3.2.1 Note 2 2.3.4 Note 2 2.6.3.3 Note 2 & 3 2.7.1 Note 2.10.3.2 Note 2 2.10.5.13 Note 3 3.2.1.1 Note 3.2.4 Note 3. 2.5.1 Note 2 4.3.6 Note 1 & 2 4.7 Note 4 4.7.2.2 Note 4.7.3.1 Note 2 5.1.7.1 Note 3 & 4 5.3.7 Note 1 6 Note 2 & 5 6.1.2.1 Note 2 6.1.2.2 Note 6.2.2 Note 6.2.2.1 Note 2 6.2.2.2 Note 7.1 Note 3 7.2 Note 7.3 Note 1 & 2 G.2.1 Note 2 Annex H Note 2		P
General (A1:2010)	Delete all the “country” notes in the reference document (IEC 60950-1:2005/A1:2010) according to the following list: 1.5.7.1 Note 6.1.2.1 Note 2 6.2.2.1 Note 2 EE.3 Note		N/A

National Differences			
Clause	Requirement + Test	Result - Remark	Verdict
1.3.Z1	Add the following subclause: 1.3.Z1 Exposure to excessive sound pressure The apparatus shall be so designed and constructed as to present no danger when used for its intended purpose, either in normal operating conditions or under fault conditions, particularly providing protection against exposure to excessive sound pressures from headphones or earphones. NOTE Z1 A new method of measurement is described in EN 50332-1, Sound system equipment: Headphones and earphones associated with portable audio equipment - Maximum sound pressure level measurement methodology and limit considerations - Part 1: General method for "one package equipment", and in EN 50332-2, Sound system equipment: Headphones and earphones associated with portable audio equipment - Maximum sound pressure level measurement methodology and limit considerations - Part 2: Guidelines to associate sets with headphones coming from different manufacturers.	Not such equipment.	N/A
(A12:2011)	In EN 60950-1:2006/A12:2011 Delete the addition of 1.3.Z1 / EN 60950-1:2006 Delete the definition 1.2.3.Z1 / EN 60950-1:2006 /A1:2010	Deleted.	N/A
1.5.1	Add the following NOTE: NOTE Z1 The use of certain substances in electrical and electronic equipment is restricted within the EU: see Directive 2002/95/EC	Added.	P
1.7.2.1 (A1:2010)	In addition, for a PORTABLE SOUND SYSTEM, the instructions shall include a warning that excessive sound pressure from earphones and headphones can cause hearing loss.	Added.	N/A
1.7.2.1 (A12:2011)	In EN 60950-1:2006/A12:2011 Delete NOTE Z1 and the addition for Portable Sound System. Add the following clause and annex to the existing standard and amendments.	Replaced.	P
	Zx Protection against excessive sound pressure from personal music players		N/A

National Differences			
Clause	Requirement + Test	Result - Remark	Verdict
	<p>Zx.1 General This sub-clause specifies requirements for protection against excessive sound pressure from personal music players that are closely coupled to the ear. It also specifies requirements for earphones and headphones intended for use with personal music players.</p> <p>A personal music player is a portable equipment□ for personal use, that:</p> <ul style="list-style-type: none"> -is designed to allow the user to listen to recorded or broadcast sound or video; and -primarily uses headphones or earphones that can be worn in or on or around the ears; and -allows the user to walk around while in use. <p>NOTE 1 Examples are hand-held or body-worn portable CD players, MP3 audio players, mobile phones with MP3 type features, PDA's or similar equipment.</p> <p>A personal music player and earphones or headphones intended to be used with personal music players shall comply with the requirements of this sub-clause.</p> <p>The requirements in this sub-clause are valid for music or video mode only.</p> <p>The requirements do not apply:</p> <ul style="list-style-type: none"> -while the personal music player is connected to an external amplifier; or -while the headphones or earphones are not used. <p>NOTE 2 An external amplifier is an amplifier which is not part of the personal music player or the listening device, but which is intended to play the music as a standalone music player.</p> <p>The requirements do not apply to:</p> <ul style="list-style-type: none"> -hearing aid equipment and professional equipment; <p>NOTE 3 Professional equipment is equipment sold through special sales channels. All products sold through normal electronics stores are considered not to be professional equipment.</p>	Not such equipment.	N/A
	<p>-analogue personal music players (personal music players without any kind of digital processing of the sound signal) that are brought to the market before the end of 2015.</p> <p>NOTE 4 This exemption has been allowed because this technology is falling out of use and it is expected that within a few years it will no longer exist. This exemption will not be extended to other technologies.</p> <p>For equipment which is clearly designed or intended for use by young children, the limits of EN 71-1 apply.</p>		

National Differences			
Clause	Requirement + Test	Result - Remark	Verdict
	<p>Zx.2 Equipment requirements No safety provision is required for equipment that complies with the following: -equipment provided as a package (personal music player with its listening device), where the acoustic output $L_{Aeq,T}$ is ≤ 85 dBA measured while playing the fixed "programme simulation noise" as described in EN 50332-1; and -a personal music player provided with an analogue electrical output socket for a listening device, where the electrical output is ≤ 27 mV measured as described in EN 50332-2, while playing the fixed "programme simulation noise" as described in EN 50332-1.</p> <p>NOTE 1 Wherever the term acoustic output is used in this clause, the 30 s A-weighted equivalent sound pressure level $L_{Aeq,T}$ is meant. See also Zx.5 and Annex Zx.</p> <p>All other equipment shall: a) protect the user from unintentional acoustic outputs exceeding those mentioned above; and b) have a standard acoustic output level not exceeding those mentioned above, and automatically return to an output level not exceeding those mentioned above when the power is switched off; and</p>	Not such equipment.	N/A

National Differences			
Clause	Requirement + Test	Result - Remark	Verdict
	<p>c) provide a means to actively inform the user of the increased sound pressure when the equipment is operated with an acoustic output exceeding those mentioned above. Any means used shall be acknowledged by the user before activating a mode of operation which allows for an acoustic output exceeding those mentioned above. The acknowledgement does not need to be repeated more than once every 20 h of cumulative listening time; and</p> <p>NOTE 2 Examples of means include visual or audible signals. Action from the user is always required.</p> <p>NOTE 3 The 20 h listening time is the accumulative listening time, independent how often and how long the personal music player has been switched off.</p> <p>d) have a warning as specified in Zx.3; and</p> <p>e) not exceed the following:</p> <ol style="list-style-type: none"> 1) equipment provided as a package (player with its listening device), the acoustic output shall be ≤ 100 dBA measured while playing the fixed "programme simulation noise" described in EN 50332-1; and 2) a personal music player provided with an analogue electrical output socket for a listening device, the electrical output shall be ≤ 150 mV measured as described in EN 50332-2, while playing the fixed "programme simulation noise" described in EN 50332-1. <p>For music where the average sound pressure (long term $L_{Aeq,T}$) measured over the duration of the song is lower than the average produced by the programme simulation noise, the warning does not need to be given as long as the average sound pressure of the song is below the basic limit of 85 dBA. In this case T becomes the duration of the song.</p> <p>NOTE 4 Classical music typically has an average sound pressure (long term $L_{Aeq,T}$) which is much lower than the average programme simulation noise. Therefore, if the player is capable to analyse the song and compare it with the programme simulation noise, the warning does not need to be given as long as the average sound pressure of the song is below the basic limit of 85 dBA.</p> <p>For example, if the player is set with the programme simulation noise to 85 dBA, but the average music level of the song is only 65 dBA, there is no need to give a warning or ask an acknowledgement as long as the average sound level of the song is not above the basic limit of 85 dBA.</p>	Not such equipment.	N/A

National Differences

Clause	Requirement + Test	Result - Remark	Verdict
	<p>Zx.3 Warning The warning shall be placed on the equipment, or on the packaging, or in the instruction manual and shall consist of the following: -the symbol of Figure 1 with a minimum height of 5 mm; and -the following wording, or similar: "To prevent possible hearing damage, do not listen at high volume levels for long periods."</p>  <p>Figure 1 – Warning label (IEC 60417-6044)</p> <p>Alternatively, the entire warning may be given through the equipment display during use, when the user is asked to acknowledge activation of the higher level.</p>	Not such equipment.	N/A
	Zx.4 Requirements for listening devices (headphones and earphones)		N/A
	<p>Zx.4.1 Wired listening devices with analogue input With 94 dBA sound pressure output LAeq,T, the input voltage of the fixed "programme simulation noise" described in EN 50332-2 shall be ≥ 75 mV. This requirement is applicable in any mode where the headphones can operate (active or passive), including any available setting (for example built-in volume level control). NOTE The values of 94 dBA – 75 mV correspond with 85dBA – 27 mV and 100 dBA – 150 mV.</p>	Not such equipment.	N/A

National Differences			
Clause	Requirement + Test	Result - Remark	Verdict
	<p>Zx.4.2 Wired listening devices with digital input With any playing device playing the fixed “programme simulation noise” described in EN 50332-1 (and respecting the digital interface standards, where a digital interface standard exists that specifies the equivalent acoustic level), the acoustic output $L_{Aeq,T}$ of the listening device shall be ≤ 100 dBA.</p> <p>This requirement is applicable in any mode where the headphones can operate, including any available setting (for example built-in volume level control, additional sound feature like equalization, etc.).</p> <p>NOTE An example of a wired listening device with digital input is a USB headphone.</p>	Not such equipment.	N/A
	<p>Zx.4.3 Wireless listening devices In wireless mode: -with any playing and transmitting device playing the fixed programme simulation noise described in EN 50332-1; and -respecting the wireless transmission standards, where an air interface standard exists that specifies the equivalent acoustic level; and -with volume and sound settings in the listening device (for example built-in volume level control, additional sound feature like equalization, etc.) set to the combination of positions that maximize the measured acoustic output for the abovementioned programme simulation noise, the acoustic output $L_{Aeq,T}$ of the listening device shall be ≤ 100 dBA.</p> <p>NOTE An example of a wireless listening device is a Bluetooth headphone.</p>	Not such equipment.	N/A
	<p>Zx.5 Measurement methods Measurements shall be made in accordance with EN 50332-1 or EN 50332-2 as applicable. Unless stated otherwise, the time interval T shall be 30 s.</p> <p>NOTE Test method for wireless equipment provided without listening device should be defined.</p>	Not such equipment.	N/A

National Differences			
Clause	Requirement + Test	Result - Remark	Verdict
2.7.1	Replace the subclause as follows: Basic requirements To protect against excessive current, short-circuits and earth faults in PRIMARY CIRCUITS, protective devices shall be included either as integral parts of the equipment or as parts of the building installation, subject to the following, a), b) and c): a) except as detailed in b) and c), protective devices necessary to comply with the requirements of 5.3 shall be included as parts of the equipment; b) for components in series with the mains input to the equipment such as the supply cord, appliance coupler, r.f.i. filter and switch, short-circuit and earth fault protection may be provided by protective devices in the building installation;	Replaced.	P
	c) it is permitted for PLUGGABLE EQUIPMENT TYPE B or PERMANENTLY CONNECTED EQUIPMENT, to rely on dedicated overcurrent and short-circuit protection in the building installation, provided that the means of protection, e.g. fuses or circuit breakers, is fully specified in the installation instructions. If reliance is placed on protection in the building installation, the installation instructions shall so state, except that for PLUGGABLE EQUIPMENT TYPE A the building installation shall be regarded as providing protection in accordance with the rating of the wall socket outlet.		N/A
2.7.2	This subclause has been declared 'void'.		N/A
3.2.3	Delete the NOTE in Table 3A, and delete also in this table the conduit sizes in parentheses.	Deleted.	N/A
3.2.5.1	Replace "60245 IEC 53" by "H05 RR-F"; "60227 IEC 52" by "H03 VV-F or H03 VVH2-F"; "60227 IEC 53" by "H05 VV-F or H05 VVH2-F2". In Table 3B, replace the first four lines by the following: Up to and including 6 0,75 ^{a)} Over 6 up to and including 10 (0,75) ^{b)} 1,0 Over 10 up to and including 16 (1,0) ^{c)} 1,5 In the conditions applicable to Table 3B delete the words "in some countries" in condition ^{a)} . In NOTE 1, applicable to Table 3B, delete the second sentence.	Replaced.	N/A

National Differences			
Clause	Requirement + Test	Result - Remark	Verdict
3.3.4	In Table 3D, delete the fourth line: conductor sizes for 10 to 13 A, and replace with the following: Over 10 up to and including 16 1,5 to 2,5 1,5 to 4 Delete the fifth line: conductor sizes for 13 to 16 A	Deleted.	N/A
4.3.13.6 (A1:2010)	Replace the existing NOTE by the following: NOTE Z1 Attention is drawn to: 1999/519/EC: Council Recommendation on the limitation of exposure of the general public to electromagnetic fields 0 Hz to 300 GHz, and 2006/25/EC: Directive on the minimum health and safety requirements regarding the exposure of workers to risks arising from physical agents (artificial optical radiation).	Added.	N/A
	Standards taking into account mentioned Recommendation and Directive which demonstrate compliance with the applicable EU Directive are indicated in the OJEC.		N/A
Annex H	Replace the last paragraph of this annex by: At any point 10 cm from the surface of the OPERATOR ACCESS AREA, the dose rate shall not exceed 1 µSv/h (0,1 mR/h) (see NOTE). Account is taken of the background level. Replace the notes as follows: NOTE These values appear in Directive 96/29/Euratom. Delete NOTE 2.	Replaced.	N/A
Bibliography	Additional EN standards.		—

ZA	NORMATIVE REFERENCES TO INTERNATIONAL PUBLICATIONS WITH THEIR CORRESPONDING EUROPEAN PUBLICATIONS	—
-----------	--	---

ZB ANNEX (normative) SPECIAL NATIONAL CONDITIONS (EN)			
Clause	Requirement + Test	Result - Remark	Verdict
1.2.4.1	In Denmark , certain types of Class I appliances (see 3.2.1.1) may be provided with a plug not establishing earthing conditions when inserted into Danish socket-outlets.	Class II	N/A
1.2.13.14	In Norway and Sweden , for requirements see 1.7.2.1 and 7.3 of this annex.		N/A

National Differences			
Clause	Requirement + Test	Result - Remark	Verdict
1.5.7.1	In Finland, Norway and Sweden , resistors bridging BASIC INSULATION in CLASS I PLUGGABLE EQUIPMENT TYPE A must comply with the requirements in 1.5.7.1. In addition when a single resistor is used, the resistor must withstand the resistor test in 1.5.7.2.		N/A
1.5.8	In Norway , due to the IT power system used (see annex V, Figure V.7), capacitors are required to be rated for the applicable line-to-line voltage (230 V).		P
1.5.9.4	In Finland, Norway and Sweden , the third dashed sentence is applicable only to equipment as defined in 6.1.2.2 of this annex.	No such construction.	N/A

National Differences			
Clause	Requirement + Test	Result - Remark	Verdict
1.7.2.1	<p>In Finland, Norway and Sweden, CLASS I PLUGGABLE EQUIPMENT TYPE A intended for connection to other equipment or a network shall, if safety relies on connection to protective earth or if surge suppressors are connected between the network terminals and accessible parts, have a marking stating that the equipment must be connected to an earthed mains socket-outlet.</p> <p>The marking text in the applicable countries shall be as follows:</p> <p>In Finland: "Laite on liitettävä suojakoskettimilla varustettuun pistorasiaan"</p> <p>In Norway: "Apparatet må tilkoples jordet stikkontakt"</p> <p>In Sweden: "Apparaten skall anslutas till jordat uttag"</p> <p>In Norway and Sweden, the screen of the cable distribution system is normally not earthed at the entrance of the building and there is normally no equipotential bonding system within the building. Therefore the protective earthing of the building installation need to be isolated from the screen of a cable distribution system.</p> <p>It is however accepted to provide the insulation external to the equipment by an adapter or an interconnection cable with galvanic isolator, which may be provided by e.g. a retailer.</p> <p>The user manual shall then have the following or similar information in Norwegian and Swedish language respectively, depending on in what country the equipment is intended to be used in: "Equipment connected to the protective earthing of the building installation through the mains connection or through other equipment with a connection to protective earthing – and to a cable distribution system using coaxial cable, may in some circumstances create a fire hazard. Connection to a cable distribution system has therefore to be provided through a device providing electrical isolation below a certain frequency range (galvanic isolator, see EN 60728-11)."</p>	Class II	N/A

National Differences			
Clause	Requirement + Test	Result - Remark	Verdict
	<p>NOTE In Norway, due to regulation for installations of cable distribution systems, and in Sweden, a galvanic isolator shall provide electrical insulation below 5 MHz. The insulation shall withstand a dielectric strength of 1,5 kV r.m.s., 50 Hz or 60 Hz, for 1 min.</p> <p>Translation to Norwegian (the Swedish text will also be accepted in Norway): "Utstyr som er koplet til beskyttelsesjord via nettplugg og/eller via annet jordtilkoplet utstyr – og er tilkoplet et kabel-TV nett, kan forårsake brannfare. For å unngå dette skal det ved tilkopling av utstyret til kabel-TV nettet installeres en galvanisk isolator mellom utstyret og kabel- TV nettet." Translation to Swedish: "Utrustning som är kopplad till skyddsjord via jordat vägguttag och/eller via annan utrustning och samtidigt är kopplad till kabel-TV nät kan i vissa fall medföra risk för brand. För att undvika detta skall vid anslutning av utrustningen till kabel-TV nät galvanisk isolator finnas mellan utrustningen och kabel-TV nätet."</p>		
1.7.5	<p>In Denmark, socket-outlets for providing power to other equipment shall be in accordance with the Heavy Current Regulations, Section 107-2-D1, Standard Sheet DK 1-3a, DK 1-5a or DK 1-7a, when used on Class I equipment. For STATIONARY EQUIPMENT the socket-outlet shall be in accordance with Standard Sheet DK 1-1b or DK 1-5a.</p> <p>For CLASS II EQUIPMENT the socket outlet shall be in accordance with Standard Sheet DKA 1-4a.</p>	No socket-outlet provided.	N/A
2.2.4	In Norway , for requirements see 1.7.2.1, 6.1.2.1 and 6.1.2.2 of this annex.	No TNV.	N/A
2.3.2	In Finland, Norway and Sweden there are additional requirements for the insulation. See 6.1.2.1 and 6.1.2.2 of this annex.	No TNV.	N/A
2.3.4	In Norway , for requirements see 1.7.2.1, 6.1.2.1 and 6.1.2.2 of this annex.	No TNV.	N/A
2.6.3.3	In the United Kingdom , the current rating of the circuit shall be taken as 13 A, not 16 A.		N/A
2.7.1	In the United Kingdom , to protect against excessive currents and short-circuits in the PRIMARY CIRCUIT of DIRECT PLUG-IN EQUIPMENT, tests according to 5.3 shall be conducted, using an external protective device rated 30 A or 32 A. If these tests fail, suitable protective devices shall be included as integral parts of the DIRECT PLUG-IN EQUIPMENT, so that the requirements of 5.3 are met.		P

National Differences			
Clause	Requirement + Test	Result - Remark	Verdict
2.10.5.13	In Finland, Norway and Sweden , there are additional requirements for the insulation, see 6.1.2.1 and 6.1.2.2 of this annex.	No TNV.	N/A
3.2.1.1	<p>In Switzerland, supply cords of equipment having a RATED CURRENT not exceeding 10 A shall be provided with a plug complying with SEV 1011 or IEC 60884-1 and one of the following dimension sheets:</p> <p>SEV 6532-2.1991 Plug Type 15 3P+N+PE 250/400 V, 10 A</p> <p>SEV 6533-2.1991 Plug Type 11 L+N 250 V, 10 A</p> <p>SEV 6534-2.1991 Plug Type 12 L+N+PE 250 V, 10 A</p> <p>In general, EN 60309 applies for plugs for currents exceeding 10 A. However, a 16 A plug and socket-outlet system is being introduced in Switzerland, the plugs of which are according to the following dimension sheets, published in February 1998:</p> <p>SEV 5932-2.1998: Plug Type 25 , 3L+N+PE 230/400 V, 16 A</p> <p>SEV 5933-2.1998: Plug Type 21, L+N, 250 V, 16A</p> <p>SEV 5934-2.1998: Plug Type 23, L+N+PE 250 V, 16 A</p>		N/A
3.2.1.1	<p>In Denmark, supply cords of single-phase equipment having a rated current not exceeding 13 A shall be provided with a plug according to the Heavy Current Regulations, Section 107-2-D1.</p> <p>CLASS I EQUIPMENT provided with socket-outlets with earth contacts or which are intended to be used in locations where protection against indirect contact is required according to the wiring rules shall be provided with a plug in accordance with standard sheet DK 2-1a or DK 2-5a.</p> <p>If poly-phase equipment and single-phase equipment having a RATED CURRENT exceeding 13 A is provided with a supply cord with a plug, this plug shall be in accordance with the Heavy Current Regulations, Section 107-2-D1 or EN 60309-2.</p>	.	N/A

National Differences			
Clause	Requirement + Test	Result - Remark	Verdict
3.2.1.1	<p>In Spain, supply cords of single-phase equipment having a rated current not exceeding 10 A shall be provided with a plug according to UNE 20315:1994.</p> <p>Supply cords of single-phase equipment having a rated current not exceeding 2,5 A shall be provided with a plug according to UNE-EN 50075:1993.</p> <p>CLASS I EQUIPMENT provided with socket-outlets with earth contacts or which are intended to be used in locations where protection against indirect contact is required according to the wiring rules, shall be provided with a plug in accordance with standard UNE 20315:1994.</p> <p>If poly-phase equipment is provided with a supply cord with a plug, this plug shall be in accordance with UNE-EN 60309-2.</p>		N/A
3.2.1.1	<p>In the United Kingdom, apparatus which is fitted with a flexible cable or cord and is designed to be connected to a mains socket conforming to BS 1363 by means of that flexible cable or cord and plug, shall be fitted with a 'standard plug' in accordance with Statutory Instrument 1768:1994 - The Plugs and Sockets etc. (Safety) Regulations 1994, unless exempted by those regulations.</p> <p>NOTE 'Standard plug' is defined in SI 1768:1994 and essentially means an approved plug conforming to BS 1363 or an approved conversion plug.</p>		N/A
3.2.1.1	<p>In Ireland, apparatus which is fitted with a flexible cable or cord and is designed to be connected to a mains socket conforming to I.S. 411 by means of that flexible cable or cord and plug, shall be fitted with a 13 A plug in accordance with Statutory Instrument 525:1997 - National Standards Authority of Ireland (section 28) (13 A Plugs and Conversion Adaptors for Domestic Use) Regulations 1997.</p>		N/A
3.2.4	<p>In Switzerland, for requirements see 3.2.1.1 of this annex.</p>		N/A
3.2.5.1	<p>In the United Kingdom, a power supply cord with conductor of 1,25 mm² is allowed for equipment with a rated current over 10 A and up to and including 13 A.</p>	No power supply cord provided.	N/A
3.3.4	<p>In the United Kingdom, the range of conductor sizes of flexible cords to be accepted by terminals for equipment with a RATED CURRENT of over 10 A up to and including 13 A is:</p> <ul style="list-style-type: none"> • 1,25 mm² to 1,5 mm² nominal cross-sectional area. 		N/A

National Differences			
Clause	Requirement + Test	Result - Remark	Verdict
4.3.6	In the United Kingdom , the torque test is performed using a socket outlet complying with BS 1363 part 1:1995, including Amendment 1:1997 and Amendment 2:2003 and the plug part of DIRECT PLUG-IN EQUIPMENT shall be assessed to BS 1363: Part 1, 12.1, 12.2, 12.3, 12.9, 12.11, 12.12, 12.13, 12.16 and 12.17, except that the test of 12.17 is performed at not less than 125 °C. Where the metal earth pin is replaced by an Insulated Shutter Opening Device (ISOD), the requirements of clauses 22.2 and 23 also apply.		N/A
4.3.6	In Ireland , DIRECT PLUG-IN EQUIPMENT is known as plug similar devices. Such devices shall comply with Statutory Instrument 526:1997 - National Standards Authority of Ireland (Section 28) (Electrical plugs, plug similar devices and sockets for domestic use) Regulations, 1997.		N/A
5.1.7.1	In Finland, Norway and Sweden TOUCH CURRENT measurement results exceeding 3,5 mA r.m.s. are permitted only for the following equipment: <ul style="list-style-type: none"> • STATIONARY PLUGGABLE EQUIPMENT TYPE A that <ul style="list-style-type: none"> is intended to be used in a RESTRICTED ACCESS LOCATION where equipotential bonding has been applied, for example, in a telecommunication centre; and has provision for a permanently connected PROTECTIVE EARTHING CONDUCTOR; and is provided with instructions for the installation of that conductor by a SERVICE PERSON; • STATIONARY PLUGGABLE EQUIPMENT TYPE B; • STATIONARY PERMANENTLY CONNECTED EQUIPMENT. 	Not exceed 3.5mA.	N/A

National Differences			
Clause	Requirement + Test	Result - Remark	Verdict
6.1.2.1 (A1:2010)	<p>In Finland, Norway and Sweden, add the following text between the first and second paragraph of the compliance clause:</p> <p>If this insulation is solid, including insulation forming part of a component, it shall at least consist of either</p> <ul style="list-style-type: none"> - two layers of thin sheet material, each of which shall pass the electric strength test below, or - one layer having a distance through insulation of at least 0,4 mm, which shall pass the electric strength test below. <p>Alternatively for components, there is no distance through insulation requirements for the insulation consisting of an insulating compound completely filling the casing, so that CLEARANCES and CREEPAGE DISTANCES do not exist, if the component passes the electric strength test in accordance with the compliance clause below and in addition</p> <ul style="list-style-type: none"> - passes the tests and inspection criteria of 2.10.11 with an electric strength test of 1,5 kV multiplied by 1,6 (the electric strength test of 2.10.10 shall be performed using 1,5 kV), and - is subject to ROUTINE TESTING for electric strength during manufacturing, using a test voltage of 1,5 kV. 	No TNV.	N/A
	<p>It is permitted to bridge this insulation with an optocoupler complying with 2.10.5.4 b).</p> <p>It is permitted to bridge this insulation with a capacitor complying with EN 60384-14:2005, subclass Y2.</p> <p>A capacitor classified Y3 according to EN 60384-14:2005, may bridge this insulation under the following conditions:</p> <ul style="list-style-type: none"> - the insulation requirements are satisfied by having a capacitor classified Y3 as defined by EN 60384-14, which in addition to the Y3 testing, is tested with an impulse test of 2,5 kV defined in EN 60950-1:2006, 6.2.2.1; - the additional testing shall be performed on all the test specimens as described in EN 60384-14; - the impulse test of 2,5 kV is to be performed before the endurance test in EN 60384-14, in the sequence of tests as described in EN 60384-14. 		N/A

National Differences			
Clause	Requirement + Test	Result - Remark	Verdict
6.1.2.2	In Finland, Norway and Sweden , the exclusions are applicable for PERMANENTLY CONNECTED EQUIPMENT, PLUGGABLE EQUIPMENT TYPE B and equipment intended to be used in a RESTRICTED ACCESS LOCATION where equipotential bonding has been applied, e.g. in a telecommunication centre, and which has provision for a permanently connected PROTECTIVE EARTHING CONDUCTOR and is provided with instructions for the installation of that conductor by a SERVICE PERSON.	No TNV.	N/A
7.2	In Finland, Norway and Sweden , for requirements see 6.1.2.1 and 6.1.2.2 of this annex. The term TELECOMMUNICATION NETWORK in 6.1.2 being replaced by the term CABLE DISTRIBUTION SYSTEM.	Not connected to cable distribution system.	N/A
7.3	In Norway and Sweden , for requirements see 1.2.13.14 and 1.7.2.1 of this annex.	Not connected to cable distribution system.	N/A
7.3	In Norway , for installation conditions see EN 60728-11:2005.	Not connected to cable distribution system.	N/A

National Differences			
Clause	Requirement – Test	Result – Remark	Verdict

ATTACHMENT TO TEST REPORT IEC 60950-1 AUSTRALIA and NEW ZEALAND NATIONAL DIFFERENCES Information technology equipment – Safety – PART 1: GENERAL REQUIREMENTS			
Differences according to: AS/NZS 60950.1:2011			
1.2	Insert the following between 'person, service' and 'range, rated frequency': POTENTIAL IGNITION SOURCE 1.2.12	Inserted.	P
1.2.12.201	Insert a new Clause 1.2.12.201 after Clause 1.2.12.15 as follows: 1.2.12.201 POTENTIAL IGNITION SOURCE Possible fault which can start a fire if the open-circuit voltage measured across an interruption or faulty contact exceeds a value of 50 V (peak) a.c. or d.c. and the product of the peak value of this voltage and the measured r.m.s. current under normal operating conditions exceeds 15 VA. Such a faulty contact or interruption in an electrical connection includes those which may occur in CONDUCTIVE PATTERNS on PRINTED BOARDS. NOTE 201 An electronic protection circuit may be used to prevent such a fault from becoming a POTENTIAL IGNITION SOURCE. NOTE 202 This definition is from AS/NZS 60065:2003.	Inserted.	P
1.5.1	1. Add the following to the end of the first paragraph: 'or the relevant Australian/New Zealand Standard' 2. In NOTE 1, add the following after the word 'standard': 'or an Australian/New Zealand Standard'	Added.	P
1.5.2	Add the following to the end of the first and third dash items: 'or the relevant Australian/New Zealand Standard'	Added.	P

National Differences																				
Clause	Requirement – Test	Result – Remark	Verdict																	
3.2.5.1	<p>Modify Table 3B as follows:</p> <p>1. Delete the first four rows and replace with the following:</p> <table border="1"> <thead> <tr> <th rowspan="2">RATED CURRENT of equipment A</th> <th colspan="2">Minimum conductor sizes</th> </tr> <tr> <th>Nominal cross-sectional area mm²</th> <th>AWG or kcmil [cross-sectional area in mm²] see Note 2</th> </tr> </thead> <tbody> <tr> <td>Over 0.2 up to and including 3</td> <td>0,5^a</td> <td>18 [0,8]</td> </tr> <tr> <td>Over 3 up to and including 7.5</td> <td>0,75</td> <td>16 [1,3]</td> </tr> <tr> <td>Over 7.5 up to and including 10</td> <td>(0,75)^b 1,00</td> <td>16 [1,3]</td> </tr> <tr> <td>Over 10 up to and including 16</td> <td>(1,0)^c 1,5</td> <td>14 [2]</td> </tr> </tbody> </table> <p>2. Delete NOTE 1. 3. Delete Footnote ^a and replace with the following: ^a This nominal cross-sectional area is only allowed for Class II appliances if the length of the power supply cord, measured between the point where the cord, or cord guard, enters the appliance, and the entry to the plug does not exceed 2 m (0,5 mm² three-core supply flexible cords are not permitted; see AS/NZS 3191).</p>	RATED CURRENT of equipment A	Minimum conductor sizes		Nominal cross-sectional area mm ²	AWG or kcmil [cross-sectional area in mm ²] see Note 2	Over 0.2 up to and including 3	0,5 ^a	18 [0,8]	Over 3 up to and including 7.5	0,75	16 [1,3]	Over 7.5 up to and including 10	(0,75) ^b 1,00	16 [1,3]	Over 10 up to and including 16	(1,0) ^c 1,5	14 [2]	Considered	N/A
RATED CURRENT of equipment A	Minimum conductor sizes																			
	Nominal cross-sectional area mm ²	AWG or kcmil [cross-sectional area in mm ²] see Note 2																		
Over 0.2 up to and including 3	0,5 ^a	18 [0,8]																		
Over 3 up to and including 7.5	0,75	16 [1,3]																		
Over 7.5 up to and including 10	(0,75) ^b 1,00	16 [1,3]																		
Over 10 up to and including 16	(1,0) ^c 1,5	14 [2]																		
4.1.201	<p>Insert a new Clause 4.1.201 after Clause 4.1 as follows:</p> <p>4.1.201 Display devices used for television purposes Display devices which may be used for television purposes, with a mass of 7 kg or more, shall comply with the requirements for stability and mechanical hazards, including the additional stability requirements for television receivers, specified in AS/NZS 60065.</p>	Inserted	N/A																	
4.3.6	<p>Delete the third paragraph and replace with the following:</p> <p><i>Equipment with a plug portion, suitable for insertion into a 10 A 3-pin flatpin socket-outlet complying with AS/NZS 3112 shall comply with the requirements in AS/NZS 3112 for equipment with integral pins for insertion into socket-outlets.</i></p>		N/A																	
4.3.16.5	<p>Add the following to the end of the first paragraph: 'or AS/NZS 2211.1'</p>	Added.	N/A																	

National Differences			
Clause	Requirement – Test	Result – Remark	Verdict
4.7	Add the following new paragraph to the end of the clause: 'For alternate tests refer to Clause 4.7.201.'	Added.	N/A
4.7.201	Insert a new Clause 4.7.201 after Clause 4.7.3.6 as follows: 4.7.201 Resistance to fire – Alternative tests	Inserted	N/A
4.7.201.1	<p>4.7.201.1 General</p> <p>Parts of non-metallic material shall be resistant to ignition and spread of fire.</p> <p>This requirement does not apply to decorative trims, knobs and other parts unlikely to be ignited or to propagate flames from inside the apparatus, or the following:</p> <p>(a) Components that are contained in an enclosure having a flammability category of V-0 according to AS/NZS 60695.11.10 and having openings only for the connecting wires filling the openings completely, and for ventilation not exceeding 1mm in width regardless of length.</p> <p>(b) The following parts which would contribute negligible fuel to a fire:</p> <ul style="list-style-type: none"> - small mechanical parts, the mass of which does not exceed 4g, such as mounting parts, gears, cams, belts and bearings; - small electrical components, such as capacitors with a volume not exceeding 1,750 mm³, integrated circuits, transistors and optocoupler packages, if these components are mounted on material of flammability category V-1, or better, according to AS/NZS 60695.11.10. <p>NOTE In considering how to minimize propagation of fire and what 'small parts' are, account should be taken of the cumulative effect of small parts adjacent to each other for the possible effect of propagating the fire from one part to another.</p> <p>Compliance shall be checked by the tests of 4.7.201.2, 4.7.201.3, 4.7.201.4 and 4.7.201.5.</p> <p>For the base material of printed boards, compliance shall be checked by the test of 4.7.201.5.</p> <p>The tests shall be carried out on parts of non-metallic material which have been removed from the apparatus. When the glow-wire test is carried out, the parts shall be placed in the same orientation as they would be in normal use.</p> <p>These tests are not carried out on internal wiring.</p>		P

National Differences									
Clause	Requirement – Test	Result – Remark	Verdict						
4.7.201.2	<p>4.7.201.2 Testing of non-metallic materials</p> <p>Parts of non-metallic material shall be subject to the glow-wire test of AS/NZS 60695.2.11 which shall be carried out at 550 °C.</p> <p>Parts for which the glow-wire test cannot be carried out, such as those made of soft or foamy material, shall meet the requirements specified in ISO 9772 for category FH-3 material. The glow-wire test shall be not carried out on parts of material classified at least FH-3 according to ISO 9772 provided that the sample tested was not thicker than the relevant part.</p>		N/A						
4.7.201.3	<p>4.7.201.3 Testing of insulating materials</p> <p>Parts of insulating material supporting POTENTIAL IGNITION SOURCES shall be subject to the glow-wire test of AS/NZS 60695.2.11 which shall be carried out at 750 °C. The test shall be also carried out on other parts of insulating material which are within a distance of 3 mm of the connection.</p> <p>NOTE Contacts in components such as switch contacts are considered to be connections.</p> <p>For parts which withstand the glow-wire test but produce a flame, other parts above the connection within the envelope of a vertical cylinder having a diameter of 20 mm and a height of 50 mm shall be subjected to the needle-flame test. However, parts shielded by a barrier which meets the needle-flame test shall not be tested. The needle-flame test shall be made in accordance with AS/NZS 60695.11.5 with the following modifications:</p> <table border="1" data-bbox="391 1331 940 1915"> <tr> <td>Clause of AS/NZS 60695.11.5</td> <td>Change</td> </tr> <tr> <td colspan="2">9 Test procedure</td> </tr> <tr> <td>9.2 Application of needleflame</td> <td> Replace the first paragraph with: The specimen shall be arranged so that the flame can be applied to a vertical or horizontal edge as shown in the examples of figure 1. If possible the flame shall be applied at least 10 mm from a corner Replace the second paragraph with: The duration of </td> </tr> </table>	Clause of AS/NZS 60695.11.5	Change	9 Test procedure		9.2 Application of needleflame	Replace the first paragraph with: The specimen shall be arranged so that the flame can be applied to a vertical or horizontal edge as shown in the examples of figure 1. If possible the flame shall be applied at least 10 mm from a corner Replace the second paragraph with: The duration of		N/A
Clause of AS/NZS 60695.11.5	Change								
9 Test procedure									
9.2 Application of needleflame	Replace the first paragraph with: The specimen shall be arranged so that the flame can be applied to a vertical or horizontal edge as shown in the examples of figure 1. If possible the flame shall be applied at least 10 mm from a corner Replace the second paragraph with: The duration of								

National Differences				
Clause	Requirement – Test		Result – Remark	Verdict
		application of the test flame shall be 30 s ±1 s.		
	9.3 Number of test specimens	Replace with: The test shall be made on one specimen. If the specimen does not withstand the test, the test may be repeated on two further specimens, both of which shall withstand the test.		
	11 Evaluation of test results	Replace with: The duration of burning (t_b) shall not exceed 30 s. However, for printed circuit boards, it shall not exceed 15 s.		
	The needle-flame test shall not be carried out on parts of material classified as V-0 or V-1 according to AS/NZS 60695.11.10, provided that the sample tested was not thicker than the relevant part.			
4.7.201.4	<p>4.7.201.4 Testing in the event of non-extinguishing material</p> <p>If parts, other than enclosures, do not withstand the glow wire tests of 4.7.201.3, by failure to extinguish within 30 s after the removal of the glowwire tip, the needle-flame test detailed in 4.7.201.3 shall be made on all parts of non-metallic material which are within a distance of 50 mm or which are likely to be impinged upon by flame during the tests of 4.7.201.3. Parts shielded by a separate barrier which meets the needle-flame test need not be tested.</p> <p>NOTE 1 If the enclosure does not withstand the glow-wire test the equipment is considered to have failed to meet the requirements of Clause 4.7.201 without the need for consequential testing.</p> <p>NOTE 2 If other parts do not withstand the glow-wire test due to ignition of the tissue paper and if this indicates that burning or glowing particles can fall onto an external surface underneath the equipment, the equipment is considered to have failed to meet the requirements of Clause 4.7.201 without the need for consequential testing.</p> <p>NOTE 3 Parts likely to be impinged upon by the flame are considered to be those within the envelope of a vertical cylinder having a radius of 10 mm and a height equal to the height of the flame, positioned above the point of the material supporting, in contact with, or in close proximity to, connections.</p>			N/A
4.7.201.5	4.7.201.5 Testing of printed boards			N/A

National Differences			
Clause	Requirement – Test	Result – Remark	Verdict
	<p>The base material of printed boards shall be subjected to the needle-flame test of Clause 4.7.201.3. The flame shall be applied to the edge of the board where the heat sink effect is lowest when the board is positioned as in normal use. The flame shall not be applied to an edge, consisting of broken perforations, unless the edge is less than 3 mm from a POTENTIAL IGNITION SOURCE.</p> <p>The test is not carried out if the —</p> <ul style="list-style-type: none"> - Printed board does not carry any POTENTIAL IGNITION SOURCE; - Base material of printed boards, on which the available apparent power at a connection exceeds 15 VA operating at a voltage exceeding 50 V and equal or less than 400 V (peak) a.c. or d.c. under normal operating conditions, is of flammability category V-1 or better according to AS/NZS 60695.11.10, or the printed boards are protected by an enclosure meeting the flammability category V-0 according to AS/NZS 60695.11.10, or made of metal, having openings only for connecting wires which fill the openings completely; or - Base material of printed boards, on which the available apparatus power at a connection exceeds 15 VA operating at a voltage exceeding 400 V (peak) a.c. or d.c. under normal operating conditions, and base material of printed boards supporting spark gaps which provides protection against overvoltages, is of flammability category V-0 according to AS/NZS 60695.11.10 or the printed boards are contained in a metal enclosure, having openings only for connecting wires which fill the openings completely. <p>Compliance shall be determined using the smallest thickness of the material.</p> <p>NOTE Available apparent power is the maximum apparent power which can be drawn from the supplying circuit through a resistive load whose value is chosen to maximise the apparent power for more than 2 min when the circuit supplied is disconnected.</p>		
6.2.2	<p>For Australia only, delete the first paragraph and Note, and replace with the following: In Australia only, compliance with 6.2.2 shall be checked by the tests of both 6.2.2.1 and 6.2.2.2.</p>		N/A

National Differences			
Clause	Requirement – Test	Result – Remark	Verdict
6.2.2.1	<p>For Australia only, delete the first paragraph including the Notes, and replace with the following:</p> <p><i>In Australia only, the electrical separation is subjected to 10 impulses of alternating polarity, using the impulse test generator reference 1 of Table N.1. The interval between successive impulses is 60 s and the initial voltage, U_c, is:</i></p> <p><i>(i) for 6.2.1 a): 7.0 kV for hand-held telephones and for headsets and 2.5 kV for other equipment; and</i></p> <p><i>(ii) for 6.2.1 b) and 6.2.1 c): 1.5 kV.</i></p> <p>NOTE 201 The 7 kV impulse simulates lightning surges on typical rural and semi-rural network lines. NOTE 202 The value of 2.5 kV for 6.2.1 a) was chosen to ensure the adequacy of the insulation concerned and does not necessarily simulate likely overvoltages.</p>		N/A
6.2.2.2	<p>For Australia only, delete the second paragraph including the Note, and replace with the following:</p> <p><i>In Australia only, the a.c. test voltage is:</i></p> <p><i>(i) for 6.2.1 a): 3 kV; and</i></p> <p><i>(ii) for 6.2.1 b) and 6.2.1 c): 1.5 kV.</i></p> <p>NOTE 201 Where there are capacitors across the insulation under test, it is recommended that d.c. test voltages are used. NOTE 202 The 3 kV and 1.5 kV values have been determined considering the low frequency induced voltages from the power supply distribution system.</p>		N/A
7.3	<p>Add the following before the first paragraph:</p> <p>Equipment providing functions that fall only within the scope of AS/NZS 60065 and that incorporate a PSTN interface, are not required to comply with this Clause where the only ports provided on the equipment, in addition to a coaxial cable connection and a PSTN interface, are audio or video ports and analogue or data ports not intended to be used for telecommunications purposes.</p>		N/A
Annex P	<p>Normative references (List of relevant Australia/New Zealand Standards that have been inserted in place of some of the International Standards)</p>		N/A

National Differences			
Clause	Requirement – Test	Result – Remark	Verdict

ATTACHMENT TO TEST REPORT IEC 60950-1 CANADA NATIONAL DIFFERENCES Information technology equipment – Safety – PART 1: GENERAL REQUIREMENTS	
Differences according to:	CAN/CSA-C22.2 NO. 60950-1A-07
Attachment Form No	CA_ND_IEC60950_1C
Attachment Originator	TÜV SÜD Product Service GmbH
Master Attachment	Date (2012-08)
Copyright © 2012 IEC System for Conformity Testing and Certification of Electrical Equipment (IECEE), Geneva, Switzerland. All rights reserved.	

	Special national conditions		
1.1.1	All equipment is to be designed to allow installation in accordance with the National Electrical Code (NEC), ANSI/NFPA 70, the Canadian Electrical Code (CEC), Part I, CAN/CSA C22.1, and when applicable, the National Electrical Safety Code, IEEE C2.	Complied.	P
	Also, unless marked or otherwise identified, installation is allowed per the Standard for the Protection of Electronic Computer/Data-Processing Equipment, ANSI/NFPA 75.		P
1.4.14	For Pluggable Equipment Type A, the protection in the installation is assumed to be 20A.	Considered.	P
1.5.5	For lengths exceeding 3.05 m, external interconnecting flexible cord and cable assemblies are required to be a suitable cable type (e.g., DP, CL2) specified in the CEC/NEC.	No power cord provided.	N/A
	For lengths 3.05 m or less, external interconnecting flexible cord and cable assemblies that are not types specified in the CEC are required to have special construction features and identification markings.	Approved by UL/CSA.	P

National Differences			
Clause	Requirement – Test	Result – Remark	Verdict
1.7.1	Equipment for use on a.c. mains supply systems with a neutral and more than one phase conductor (e.g. 120/240 V, 3-wire) require a special marking format for electrical ratings.	Single-phase equipment.	N/A
	A voltage rating that exceeds an attachment plug cap rating is only permitted if it does not exceed the extreme operating conditions in Table 2 of CAN/CSA C22.2 No. 235, and		N/A
	- if it is part of a range that extends into the Table 2 "Normal Operating Conditions."		N/A
	A voltage rating is not be lower than the specified "Normal Operating Conditions," unless it is part of a range that extends into the "Normal Operating Conditions."		N/A
1.7.7	Wiring terminals intended to supply Class 2 outputs in accordance with CEC Part 1 or NEC are marked with the voltage rating and "Class 2" or equivalent.	No wiring terminals.	N/A
	- Marking is located adjacent to the terminals		N/A
	- Marking is visible during wiring		N/A
2.5	Fuse providing Class 2, Limited Power Source, or TNV current limiting is not operator-accessible unless it is not interchangeable.	No such fuses.	N/A
2.6.3.3	Modify first column on Table 2D to "Smaller of the RATED CURRENT of the equipment or the PROTECTIVE CURRENT RATING of the circuit under consideration."		P
2.7.1	Suitable NEC/CEC branch circuit protection rated at the maximum circuit rating is provided for all standard supply outlets and receptacles (such as supplied in power distribution units) if the supply branch circuit protection is not suitable.	No such components provided.	N/A
	Power distribution transformers distributing power at 100 volts or more, and rated 10 kVA or more, provided with special transformer overcurrent protection.		N/A

National Differences			
Clause	Requirement – Test	Result – Remark	Verdict
3.2	Wiring methods (terminals, leads, etc.) used for the connection of the equipment to the mains is in accordance with the NEC/CEC.		N/A
3.2.1	Attachment plugs of power supply cords are rated not less than 125 percent of the rated current of the equipment.		N/A
3.2.1.2	Equipment connected to a centralized d.c. power system, and having one pole of the DC mains input terminal connected to the main protective earthing terminal in the equipment comply with special earthing, wiring, marking and installation instruction requirements.	No connection to a centralized d.c. power system.	N/A
3.2.3	Permanent connection of equipment to the mains supply by a power supply cord is not permitted, except for certain equipment, such as ATMs.	Pluggable equipment type A.	N/A
3.2.5	Power supply cords are no longer than 4.5 m in length.	Pluggable equipment.	N/A
	Minimum cord length is 1.5 m, with certain constructions such as external power supplies allowed to consider both input and output cord lengths into the requirement.		N/A
	Flexible power supply cords are compatible with Article 400 of the NEC, and Tables 11 and 12 of the CEC.		N/A
3.2.9	Permanently connected equipment have a suitable wiring compartment and wire bending space.	Pluggable equipment type A.	N/A
3.3	Wiring terminals and associated spacings for field wiring connections comply with CSA C22.2 No. 0.	No wiring terminals.	N/A
3.3.3	Wire binding screws are not permitted to attach conductors larger than 10 AWG (5.3 mm ²).	No wire binding screws.	N/A
3.3.4	Terminals for permanent wiring, including protective earthing terminals, are suitable for Canadian/US wire gauge sizes, are	Pluggable equipment type A.	N/A
	- rated 125 percent of the equipment rating, and		N/A
	- are specially marked when specified (1.7.7).		N/A

National Differences			
Clause	Requirement – Test	Result – Remark	Verdict
3.3.5	Revise first column of Table 3E to “Smaller of the RATED CURRENT of the equipment or the PROTECTIVE CURRENT RATING of the circuit under consideration.”		P
3.4.2	Motor control devices are provided for cord-connected equipment with a motor if the equipment is rated more than 12 A,	Equipment is not such a device.	N/A
	- or if the motor has a nominal voltage rating greater than 120 V		N/A
	- or is rated more than 1/3 hp (locked rotor current over 43 A)		N/A
3.4.8	Vertically-mounted disconnect switches and circuit breakers have the "on" position indicated by the handle in the up position.	No such devices incorporated.	N/A
3.4.11	For computer room applications, equipment with battery systems capable of supplying 750 VA for five minutes have a battery disconnect means that may be connected to the computer room remote power-off circuit.	Not such an application.	N/A
4.3.12	The maximum quantity of flammable liquid stored in equipment complies with NFPA 30.	No liquids provided.	N/A
4.3.13.5	Equipment with lasers meet the Canadian Radiation Emitting Devices Act, REDR C1370 and/or Code of Federal Regulations 21 CFR 1040, as applicable.	No laser provided.	N/A
4.7	For computer room applications, automated information storage systems with combustible media greater than 0.76 m ³ (27 cu ft) have a provision for connection of either automatic sprinklers or a gaseous agent extinguishing system with an extended discharge.	Not such an application.	N/A
4.7.3.1	For computer room applications, enclosures with combustible material measuring greater than 0.9 m ² (10 sq ft) or a single dimension greater than 1.8 m (6 ft) have a flame spread rating of 50 or less.	Not such an application.	N/A

National Differences			
Clause	Requirement – Test	Result – Remark	Verdict
	For other applications, enclosures with the same dimensions require a flame spread rating of 200 or less.	Not such an application.	N/A
Annex H	Equipment that produces ionizing radiation comply with the Canadian Radiation Emitting Devices Act, REDR C1370 and/or Code of Federal Regulations, 21 CFR 1020, as applicable.	No ionizing radiation.	N/A
	Other National Differences		P
1.5.1	Some components and materials associated with the risk of fire, electric shock, or personal injury have component or material ratings in accordance with the applicable national (Canadian and/or U.S.) component or material standard requirements.	(See appended table 1.5.1)	P
1.6.1.2	A circuit for connection to the DC Mains Supply is classified as either a SELV Circuit, TNV-2 Circuit or Hazardous Voltage Circuit depending on the maximum operating voltage of the supply.	No connection to the DC Mains Supply.	N/A
	This maximum operating voltage includes consideration of the battery charging “float voltage” associated with the intended supply system, regardless of the marked power rating of the equipment.		N/A
2.3.1	For TNV-2 and TNV-3 circuits with other than ringing signals and with voltages exceeding 42.4 V _{peak} or 60 V _{d.c.} , the maximum acceptable current through a 2000 ohm resistor (or greater) connected across the voltage source with other loads disconnected is 7.1 mA peak or 30 mA d.c. under normal operating conditions.	No TNV circuits.	N/A
2.3.2.1	In the event of a single fault between TNV and SELV circuits, the limits of 2.2.3 apply to SELV Circuits and accessible conductive parts.	No TNV circuits.	N/A
2.6.3.4	Protective bonding conductors of non-standard protective bonding constructions (e.g., printed circuit traces) may be subjected to the additional limited short circuit test conditions specified.	Class II equipment.	N/A

National Differences			
Clause	Requirement – Test	Result – Remark	Verdict
4.2.8.1	Enclosures around CRTs with a face diameter of 160 mm or more reduce the risk of injury due to the implosion of the CRT.	No CRTs.	N/A
4.3.2	Equipment with handles complies with special loading tests.	No handle on equipment.	N/A
5.1.8.3	Equipment intended to receive telecommunication ringing signals comply with a special touch current measurement tests.	No TNV circuits.	N/A
5.3.7	Internal (e.g., card cage) SELV circuit connectors and printed wiring board connectors that are accessible to the operator and that deliver power are overloaded.	Considered.	P
	During abnormal operating testing, if a circuit is interrupted by the opening of a component, the test shall be repeated twice (three tests total) using new components as necessary	Considered.	P
6.4	Equipment intended for connection to telecommunication network outside plant cable is protected against overvoltage from power line crosses in accordance with 6.4 and Annex NAC.	No TNV circuits.	N/A
Annex EE	Articulated accessibility probe (Fig EE.3) is used for assessing accessibility to document/media shredders instead of the Figure 2A test finger.	Not such equipment.	N/A
M.2	Continuous ringing signals up to 16 mA only are permitted if the equipment is subjected to special installation and performance restrictions.	No TNV circuits.	N/A
Annex NAD	Equipment connected to a telecommunication and cable distribution networks and supplied with an earphone intended to be held against, or in the ear comply with special acoustic pressure requirements.	No TNV circuits.	N/A

National Differences			
Clause	Requirement – Test	Result – Remark	Verdict
	Korean National Differences		P
	Corresponding National Standard: K 60950-1		P
1.5.101	Addition: Plugs for the connection of the apparatus to the supply mains shall comply with the Korean requirement (KSC 8305).	.	N/A
8	Addition: EMC The apparatus shall comply with the relevant CISPR standards.	To be evaluated when submitted for national approval.	N/A

National Differences			
Clause	Requirement – Test	Result – Remark	Verdict
APPENDIX	USA National Differences according to CB Bulletin (UL60950-1 2 nd Edition + Amd 1) (IEC Publication 60950-1:2005+A1)		P
EXPLANATION FOR ABBREVIATIONS P=Pass, F=Fail, N/A=Not applicable. Placed in the column to the right.			
Special National Conditions			
1.1.1	All equipment is to be designed to allow installation in accordance with the National Electrical Code (NEC), ANSI/NFPA 70, the Canadian Electrical Code (CEC), Part I, CAN/CSA C22.1, and when applicable, the National Electrical Safety Code, IEEE C2. Also, unless marked or otherwise identified, installation is allowed per the Standard for the Protection of Electronic Computer/Data-Processing Equipment, ANSI/NFPA 75.		P
1.4.14	For Pluggable Equipment Type A, the protection in the installation is assumed to be 20A.		P
1.5.5	For lengths exceeding 3.05 m, external interconnecting flexible cord and cable assemblies are required to be a suitable cable type (e.g., DP, CL2) specified in the CEC/NEC. For lengths 3.05 m or less, external interconnecting flexible cord and cable assemblies that are not types specified in the CEC are required to have special construction features and identification markings.	No power cord provided.	N/A
1.7.1	Equipment for use on a.c. mains supply systems with a neutral and more than one phase conductor (e.g. 120/240 V, 3-wire) require a special marking format for electrical ratings. A voltage rating that exceeds an attachment plug cap rating is only permitted if it does not exceed the extreme operating conditions in Table 2 of CAN/CSA C22.2 No. 235, and if it is part of a range that extends into the Table 2 "Normal Operating Conditions." Likewise, a voltage rating shall not be lower than the specified "Normal Operating Conditions," unless it is part of a range that extends into the "Normal Operating Conditions."	Single-phase equipment.	N/A
1.7.7	Wiring terminals intended to supply Class 2 outputs in accordance with CEC Part 1 or NEC shall be marked with the voltage rating and "Class 2" or equivalent. Marking shall be located adjacent to the terminals and shall be visible during wiring.	No wiring terminals.	N/A
2.5	Where a fuse is used to provide Class 2, Limited Power Source, or TNV current limiting, it shall not be operator-accessible unless it is not interchangeable.	No such fuses.	N/A

National Differences			
Clause	Requirement – Test	Result – Remark	Verdict
2.6.3.3	The first column on Table 2D modified to require, “Smaller of the RATED CURRENT of the equipment or the PROTECTIVE CURRENT RATING of the circuit under consideration.”		N/A
2.7.1	Suitable NEC/CEC branch circuit protection rated at the maximum circuit rating is required for all standard supply outlets and receptacles (such as supplied in power distribution units) if the supply branch circuit protection is not suitable. Power distribution transformers distributing power at 100 volts or more, and rated 10 kVA or more, require special transformer overcurrent protection.	No such components provided.	N/A
3.2	Wiring methods (terminals, leads, etc.) used for the connection of the equipment to the mains shall be in accordance with the NEC/CEC.		N/A
3.2.1	Power supply cords are required to have attachment plugs rated not less than 125 percent of the rated current of the equipment.		N/A
3.2.1.2	Equipment connected to a centralized d.c. power system, and having one pole of the DC mains input terminal connected to the main protective earthing terminal in the equipment, is required to comply with special earthing, wiring, marking and installation instruction requirements.	No connection to a centralized d.c. power system.	N/A
3.2.3	Permanent connection of equipment to the mains supply by a power supply cord is not permitted, except for certain equipment, such as ATMs.	Pluggable equipment type A.	N/A
3.2.5	Power supply cords are required to be no longer than 4.5 m in length. Flexible power supply cords are required to be compatible with Tables 11 and 12 of the CEC and Article 400 of the NEC.		N/A
3.2.9	Permanently connected equipment is required to have a suitable wiring compartment and wire bending space.	Pluggable equipment type A.	N/A
3.3	Wiring terminals and associated spacings for field wiring connections shall comply with CSA C22.2 No. 0.	No such terminals provided.	N/A
3.3.3	Wire binding screws are not permitted to attach conductors larger than 10 AWG (5.3 mm ²).	No such screws provided.	N/A
3.3.4	Terminals for permanent wiring, including protective earthing terminals, are required to be suitable for Canadian/US wire gauge sizes, rated 125 percent of the equipment rating, and be specially marked when specified (1.7.7).	No such terminals provided.	N/A
3.3.5	First column of Table 3E revised to require “Smaller of the RATED CURRENT of the equipment or the PROTECTIVE CURRENT RATING of the circuit under consideration.”		N/A

National Differences			
Clause	Requirement – Test	Result – Remark	Verdict
3.4.2	Motor control devices are required for cord-connected equipment with a motor if the equipment is rated more than 12 A, or if the motor has a nominal voltage rating greater than 120 V, or is rated more than 1/3 hp (locked rotor current over 43 A).	Equipment is not such a device.	N/A
3.4.8	Vertically-mounted disconnect switches and circuit breakers are required to have the "on" position indicated by the handle in the up position.	No such devices incorporated.	N/A
3.4.11	For computer room applications, equipment with battery systems capable of supplying 750 VA for five minutes are required to have a battery disconnect means that may be connected to the computer room remote power-off circuit.	Not such an application.	N/A
4.3.12	The maximum quantity of flammable liquid stored in equipment is required to comply with NFPA 30.	No liquids provided.	N/A
4.3.13.5	Equipment with lasers is required to meet the Canadian Radiation Emitting Devices Act, REDR C1370 and/or Code of Federal Regulations 21 CFR 1040, as applicable.	No laser provided.	N/A
4.7	For computer room applications, automated information storage systems with combustible media greater than 0.76 m ³ (27 cu ft) are required to have a provision for connection of either automatic sprinklers or a gaseous agent extinguishing system with an extended discharge.	Not such an application.	N/A
4.7.3.1	For computer room applications, enclosures with combustible material measuring greater than 0.9 m ² (10 sq ft) or a single dimension greater than 1.8 m (6 ft) are required to have a flame spread rating of 50 or less. For other applications, enclosures with the same dimensions require a flame spread rating of 200 or less.	Not such an application.	N/A
Annex H	Equipment that produces ionizing radiation is required to comply with the Canadian Radiation Emitting Devices Act, REDR C1370 and/or Code of Federal Regulations, 21 CFR 1020, as applicable.	No ionizing radiation.	N/A

National Differences			
Clause	Requirement – Test	Result – Remark	Verdict
	<p>Other Differences</p> <p>The following key national differences are based on requirements other than national regulatory requirements</p>		P
1.5.1	<p>Some components and materials associated with the risk of fire, electric shock, or personal injury are required to have component or material ratings in accordance with the applicable national (Canadian and/or U.S.) component or material standard requirements. These components include:</p> <p>attachment plugs, battery packs (rechargeable type, used with transportable equipment), cathode ray tubes, circuit breakers, communication circuit accessories, connectors (used for current interruption of non-LPS circuits), cord sets and power supply cords, direct plug-in equipment, enclosures (outdoor), flexible cords and cables, fuses (branch circuit), fuseholders, ground-fault current interrupters, industrial control equipment, insulating tape, interconnecting cables, lampholders, limit controls, printed wiring, protectors for communications circuits, receptacles, solid state controls, supplementary protectors, switches (including interlock switches), thermal cutoffs, thermostats, (multi-layer) transformer winding wire, transient voltage surge suppressors, tubing, wire connectors, and wire and cables.</p>	(See appended table 1.5.1)	P
1.6.1.2	A circuit for connection to the DC Mains Supply is classified as either a SELV Circuit, TNV-2 Circuit or Hazardous Voltage Circuit depending on the maximum operating voltage of the supply. This maximum operating voltage shall include consideration of the battery charging “float voltage” associated with the intended supply system, regardless of the marked power rating of the equipment.	No connection to the DC Mains Supply.	N/A
2.3.1	For TNV-2 and TNV-3 circuits with other than ringing signals and with voltages exceeding 42.4 V _{peak} or 60 V _{d.c.} , the maximum acceptable current through a 2000 ohm resistor (or greater) connected across the voltage source with other loads disconnected is 7.1 mA peak or 30 mA d.c. under normal operating conditions.	No TNV circuits.	N/A
2.3.2.1	In the event of a single fault between TNV and SELV circuits, the limits of 2.2.3 apply to SELV Circuits and accessible conductive parts.	No TNV circuits.	N/A
2.6.3.4	Protective bonding conductors of non-standard protective bonding constructions (e.g., printed circuit traces) may be subjected to the additional limited short circuit test conditions specified.	Class II equipment	N/A

National Differences			
Clause	Requirement – Test	Result – Remark	Verdict
4.2.8.1	Enclosures around CRTs with a face diameter of 160 mm or more are required to reduce the risk of injury due to the implosion of the CRT.	No CRT.	N/A
4.3.2	Equipment with handles is required to comply with special loading tests.	No handle on equipment.	N/A
5.1.8.3	Equipment intended to receive telecommunication ringing signals is required to comply with a special touch current measurement tests.	No TNV circuits.	N/A
5.3.7	Internal (e.g., card cage) SELV circuit connectors and printed wiring board connectors that are accessible to the operator and that deliver power are to be overloaded. During abnormal operating testing, if a circuit is interrupted by the opening of a component, the test shall be repeated twice (three tests total) using new components as necessary.	Considered.	P
6.4	Equipment intended for connection to telecommunication network outside plant cable is required to be protected against overvoltage from power line crosses in accordance with 6.4 and Annex NAC.	No TNV circuits.	N/A
Annex EE	UL articulated accessibility probe (Fig EE.3) required for assessing accessibility to document/media shredders instead of the Figure 2A test finger.		N/A
M.2	Continuous ringing signals up to 16 mA only are permitted if the equipment is subjected to special installation and performance restrictions.	No TNV circuits.	N/A
Annex NAD	Equipment connected to a telecommunication and cable distribution networks and supplied with an earphone intended to be held against, or in the ear is required to comply with special acoustic pressure requirements.	No TNV circuits.	N/A

National Differences			
Clause	Requirement – Test	Result – Remark	Verdict
J 60950-1 (H22) : 2009 TEST REPORT (Deviations from IEC 60950-1:2001, first edition) Special National conditions, National deviation and other information according to MITI Ordinance No. 85. <u>Japanese unique deviations</u> in J60950-1(H22):2009(=JIS C 6950-1:2009)			
1.1.A	Add this sub-clause See Annex P for normative references	Considered	P
1.2	Add the following terms. Equipment, Class 0I 1.2.4.3A	Added	N/A
1.2.4.1	Add the following NOTE 2: NOTE 2 – Even in the case of CLASS 0I equipment, two-pins plug with a protective earthing lead wire (an adapter for converting a Class 0I equipment plug into a two-pin plug without earthing wire) and cord sets having a two-pin type plug with a lead wire for earthing are also regarded as Class 0I equipment if they are included in packaging as accessories or if users are recommended to use them.	Added. The equipment is “Protection Class II”	N/A
1.2.4.3A	Add this sub-clause: CLASS 0I EQUIPMENT: Equipment where protection against electric shock is achieved by: using BASIC INSULATION, and providing a means of connecting to the protective earthing conductor in the building wiring those conductive parts that are otherwise capable of assuming HAZARDOUS VOLTAGES if the BASIC INSULATION fails, and using a supply cord without earthing conductor and a plug without earthing wire although the equipment has externally an earth terminal or a lead wire for earthing. Equipment provided with a cord set having a two-pin type plug with a lead wire for earthing is also regarded as Class 0I. NOTE – Class 0I equipment may have a part constructed with Double Insulation or Reinforced Insulation as well as an operating part as SELV circuit.	Added. The equipment is “Protection Class II”	N/A

National Differences			
Clause	Requirement – Test	Result – Remark	Verdict
1.3.2	<p>Add the following NOTE 1 and 2:</p> <p>Note1: transportable equipments or similar equipments that are frequently transported for use should not be considered Class I or Class 0I equipments. However, this shall not apply to equipments that are intended for installation by service personnel or installation personnel.</p> <p>Note 2: in consideration of the state of electrical power distribution in Japan, it is best to avoid the use of Class I or Class 0I devices if it is evident that it will be difficult to connect earthing during installation of the equipment. However, this shall not apply to devices that are intended for installation by service personnel or installation personnel.</p>	<p>Added.</p> <p>The equipment is “Protection Class II”</p>	N/A
1.5.1	<p>When safety issues apply, in the absence of matters required by these specifications or JIS stipulated required matters concerning safety of related components, or in the absence of JIS concerning the component, the component must comply with one of the related IEC safety requirements. However, if a component compliant with ministerial ordinance (1962 Trade and Commerce Ministerial Ordinance No. 85) providing technical standards for electrical products is being used in accordance with the rating indicated for that component, apply articles 1.5.4, 2.8.7 and 3.2.5; electrical power cord sets that fit with inlets for equipments regulated by the IEC 60320-1 Standards Sheet must match the dimensions indicated on the applicable IEC 60320-1 Connector Standards Sheet.</p> <p>Note 1: regarding the JIS or IEC standards related to a component as related shall be limited to cases where the component in question is clearly within the scope of application of those standards.</p>	<p>Considered</p>	P

National Differences			
Clause	Requirement – Test	Result – Remark	Verdict
1.5.2	<p>In the case of components that are certified as being in compliance with JIS harmonized with the related IEC, it must be confirmed that the component is being used correctly in accordance with the stipulated standards. In the absence of JIS harmonized with the related IEC,</p> <p>Note 1: When using an IEC 60320-1 C.14 device coupler with rated voltage less than 125 V and rated current in excess of 10A, refer to 1.7.5A.</p> <p>If JIS harmonized with the IEC related to the component does not exist concurrently with the IEC standards, or if the component is using circuitry that does not comply with its rating, the component must be tested in accordance with the conditions and within equipment. The number of samples required for testing shall normally be the same as the number required under similar standards.</p>	Considered	P
1.5.6	Replace "IEC 60384-14:1993" to "JIS C 5101-14:1998 or IEC 60384-14:1993" of this Sub-Clause		N/A
1.5.7.2	Replace "IEC 60384-14:1993" to "JIS C 5101-14:1998 or IEC 60384-14:1993" of this Sub-Clause		N/A
1.5.8	Replace "IEC 60384-14:1993" to "JIS C 5101-14:1998 or IEC 60384-14:1993" of this Sub-Clause		N/A
1.7.1	Add local importer in this sub-clause manufacturer's name or local importer or trademark or identification mark;	Shall be evaluated during national approval	N/A
1.7.5	Replace "IEC 60083" to "IEC/TR 60083:1997 or JIS C 8303:2007" of this Sub-Clause	No power outlet provided	N/A
1.7.5.A	<p>Add this sub-clause</p> <p>1.7.5A Device Coupler</p> <p>When using an IEC 60320-1 C.14 device coupler (rated current 10A) with rated voltage less than 125 V and rated current in excess of 10A, be sure to write "Only use power supply cord sets that are provided with this device" or a similar statement in the user's manual.</p>		N/A

National Differences			
Clause	Requirement – Test	Result – Remark	Verdict
1.7.17A	<p>Add this sub-clause:</p> <p><i>Marking for CLASS 0I EQUIPMENT</i></p> <p>For CLASS 0I EQUIPMENT, the following instruction shall be indicated on the visible place of the mains plug or the main body:</p> <p>“Provide an earthing connection”</p> <p><i>Example in Japanese:</i></p> <p>必ず接地接続を行って下さい</p> <p>Moreover, for CLASS 0I EQUIPMENT, the following instruction shall be indicated on the visible place of the main body or written in the operating instructions:</p> <p>“Provide an earthing connection before the mains plug is connected to the mains. And, when disconnecting the earthing connection, be sure to disconnect after pulling out the mains plug from the mains.”</p> <p><i>Example in Japanese:</i></p> <p>接地接続は必ず、電源プラグを電源につなぐ前に行ってください。又、接地接続を外す場合は、必ず電源プラグを電源から切り離してから行って下さい。</p>	<p>Added.</p> <p>The equipment is “Protection Class II”</p>	N/A
2.1.1.1	In the Item b) of this Sub-Clause, replace “IEC 60083” to “ IEC 60083 or JIS C 8303:2007”.	Replaced	P
2.6.3.2	<p>Add the following in front of 1st paragraph of this Sub-Clause.</p> <p>This also applies to the conductor of lead wire for protective earthing of CLASS 0I EQUIPMENT.</p>	<p>Added.</p> <p>The equipment is “Protection Class II”</p>	N/A
2.6.3.4	<p>Add the following in this Sub-Clause.</p> <p>(See 2.6.3.3)</p>		N/A
2.6.4.2	<p>Add the following after 1st paragraph of this Sub-Clause.</p> <p>However, this shall not apply when the Class 0I equipment is equipped with a separate main protective earthing terminal.</p>	<p>Added.</p> <p>The equipment is “Protection Class II”</p>	N/A
2.6.5.4	<p>Replace the first sentence of this Sub-Clause by:</p> <p>Protective earthing connections of CLASS I EQUIPMENT shall make earlier and break later than the supply connections in each of the following:</p>		N/A

National Differences			
Clause	Requirement – Test	Result – Remark	Verdict
2.6.5.8A	<p>Add this sub-clause:</p> <p><i>Earthing of CLASS 0I EQUIPMENT</i></p> <p>Plugs with a lead wire for earthing shall not be used for equipment having a rated voltage exceeding 150V.</p> <p>For plugs with a lead wire for earthing, the lead wire shall not be earthed by a clip.</p> <p>CLASS 0I EQUIPMENT shall be provided with an earthing terminal or lead wire for earthing in the external where easily visible.</p>	<p>Added.</p> <p>The equipment is "Protection Class II"</p>	N/A
2.10.1	Replace "IEC 60664-1" to "JIS C 0664:2003" in NOTE of this Sub-Clause	Considered	P
2.10.3.1	Replace "IEC 60664-1" to "JIS C 0664:2003" in NOTE 1 and NOTE 2		P
2.10.3.2	Replace "IEC 60664-1" to "JIS C 0664:2003" in the first sentence of this Sub-Clause		P
3.2.3	<p>Add the following after Table 3A of this Sub-Clause.</p> <p>Table 3A shall apply when a JIS C 3662 or JIS C 3663 compliant cable is used. Other cables that are used must be designed to allow suitable conduits to be run in,</p>	Not permanently connected	N/A
3.2.5.1	<p>Add the following of this Sub-Clause.</p> <p>Or must be sheathed in accordance with Section 1, Annex 1 of the ministerial ordinance (1962 Trade and Commerce Ministerial Ordinance No. 85) providing technical standards for electrical products.</p> <p>- Or must be sheathed in accordance with Section 1, Annex 1 of the ministerial ordinance (1962 Trade and Commerce Ministerial Ordinance No. 85) providing technical standards for electrical products.</p> <p>- Electric cables that comply with JIS C 3662 or JIS C 3663 have a conductor with a cross-sectional area value greater than the values provided for in Table 3B. Other electrical cables comply with relevant wiring regulations.</p> <p>Delete 1) in Table 3B.</p>		N/A
3.3.4	<p>Add the following in Table 3D</p> <p>Note: when using JIS C 3662 or JIS C 3663-compliant electrical wiring, the terminal must enable connection of electric wiring commensurate with the regulated sizes</p>		N/A

National Differences			
Clause	Requirement – Test	Result – Remark	Verdict
3.3.7	Add the following after 1 st paragraph of this Sub-Clause. ◦ However, this shall not apply to the external grounding terminals of Class 0I equipment.	Added. The equipment is “Protection Class II”	N/A
4.3.4	Add the following of this Sub-Clause. ◦ Class 0I equipment where the values for creepage distance and clearance distance of the basic insulation drop further to a level lower than that stipulated in 2.10 must be properly fixed to withstand the mechanical stress generated in the course of normal use.	Added. The equipment is “Protection Class II”	N/A
4.3.5	Replace “IEC 60083” to “JIS C 8303:2007” in the first sentence of this Sub-Clause	Replaced	P
4.3.13.3	Add the following in Table 4A Note: JIS K 7161:1994, JIS K 7162:1994, IS K 7127:1999 are available as JIS compatible with part of ISO527.	No UV radiation	N/A
4..3.13.5	Replace “IEC 60825-1” to “JIS C 6802:2005 or JIS C of this Sub-Clause	No Laser radiation	N/A
	Replace “IEC 60825-2:2000” to “JIS C 6803:2006 or IEC 60825-2:2000” of this Sub-Clause		N/A
4.5.1	Add the following to Suffix 3) of Table 4B (part one and part two). Note: When data concerning materials is unavailable, Annex 4, 1 (1) 3 of “Regarding Interpretation of Ministerial Ordinance Providing Technical Standards for Electrical Products” (June 19, 2008 Bureau of Commerce No. 3) may be applied to Item 1.	Considered	P

Attachment

The insulating materials shall not be exposed to the temperature exceeding the values when the appliance is operated at rated voltage and normal operating condition.

These values may be increased by;
8 degrees for Duty 2 appliance, and
16 degrees for Duty 3 appliance.

In order to classify the appliances, following assumptions are to be used.

Duty 1 appliances: considered to be connected to supply mains throughout the years such as refrigerators

Duty 2 appliances: considered to be connected to be in between Duty 1 and Duty 3 such as room heaters

Duty 3 appliances: considered to be connected to supply mains when it is operated for rather short time such as portable coffee mill.

Permissible temperature limits of insulating materials

Natural materials	
Material	Permissible temperature limit (°C)
Bituminous compound for filter	75, (105) 1)
Paper, cotton, silk, other natural fiber and wood	90, (105) 2)
Oil denatured natural resin	105
Silica powder	500
Mica (Hard)	500, (600) 3)
(Soft)	650, (850) 3)

Notes: 1) Value applies to thermal insulating materials.

2) Value applies to materials impregnated with varnish.

3) Value in parenthesis is applied when mechanical external force is absent.

Mica splittings and untreated mica papers

Lining	Adhesive	Permissible Temperature Limit (°C)
--------	----------	------------------------------------

Japanese Deviations for J60950-1 (H22):2009 (MITI Ordinance Clause 2)

National Differences			
Clause	Requirement – Test	Result – Remark	Verdict

	a	b	c	d	e	f	g	
None	X	X	X	X	X	X	X	130 155 180; 450, (700) ¹⁾ ; 600, (800) ²⁾ 600, (700) ¹⁾ ; 700, (850) ²⁾
Paper	X	X	X	X				130
Polyethylene terephthalate film				X				130
Glass fabric				X	X			130 155 180
Polyester nonwoven fabric, Polyester woven, and Polyethylene naphthalate film				X	X			130 155
Polyamide-imide film, Aramid film, and Polymide film						X	X	155 180

a: with asphalt base

b: with natural resin or denatured natural resin base

c: with ceramic base

d: with oil-denatured synthetic resin, alkyd orthophthalate resin or cross-linked polyester base.

e: with silicon-denatured synthetic resin, isophthalate alkyd resin, telephthalate alkyd resin or epoxy resin.

f: with silicon resin.

g: inorganic

Notes: 1) value applies to hard mica-made heating substrate.

2) value applies to soft mica-made heating substrate.

Remarks: value in parenthesis is applied when mechanical external force is absent.

Organic materials (Thermosetting Resins)

Material	Permissible temperature limit (°C)
laminated melamine resin mixed with glass fiber	75, (100) ¹⁾
moulded melamine resin mixed with: cellulose	120
inorganics	140
laminated phenol resin with: cotton fiber base	115, (85) ²⁾
paper base	120, (70) ³⁾
polyamide cloth base	75
inorganics	140
moulded phenol resin with: inorganics	150, (160) ¹⁾
others	140, (150) ¹⁾
moulded melamine phenol resin with the gravity of less than 1.55	130
moulded urea resin mixed with cellulose	90
unsaturated polyester-casting	120
laminated unsaturated polyester mixed with inorganics	140
moulded unsaturated polyester mixed with: other than organics	120
inorganic powder	140
glass fiber	155
epoxy resin-casting	120
laminated epoxy resin mixed with: inorganic	130, (140) ¹⁾
other than inorganics	110, (90) ³⁾
moulded epoxy resin mixed with inorganics	130
laminated diallyl phthalate resin mixed with inorganics	140
moulded diallyl phthalate resin mixed with: other than inorganics	130
inorganic powder	150
glass fiber	155
xylene resin-casting	140
polyamide-imide film	180
laminated silicone resin mixed with inorganics	180, (220) ¹⁾
moulded silicon resins mixed with inorganics	180, (240) ⁴⁾

National Differences			
Clause	Requirement – Test	Result – Remark	Verdict

polyimide film		210	
laminated polyimide		190	
polybutadiene-casting		120	
moulded polybutadiene mixed with inorganics		130	
laminated dipheny oxide mixed with inorganics		180	

Notes: 1) Values apply to thermal insulating materials.

2) Values apply to materials with a thickness less than 0.8 mm.

3) Values apply to materials with a thickness less than 0.8 mm when treated to retard flame.

4) Values apply to materials used for thermal insulation and to seal outlets of sheathed heating wires.

Organic materials (Thermoplastic Resins)

Material	Permissible temperature limit (°C)
methacrylic resin, cellulose resin, cellulose acetate butylate resin, ulcanise, polyethylene	50
foamed polyethylene compound for insulated conductors, polyvinyl chloride	60
polyethylene compound for insulated conductors, heat-resistant polyvinyl chloride, cross-linked polyvinyl chloride compound for insulated conductors	75
cross-linked polyethylene, chlorinated polyethylene compound for insulated conductors	90
acrylonitrile acrylic rubber styrene resin, acrylonitrile chlorinate polyethylene styrene resin	55
acrylonitrile styrene resin, acrylonitrile butadiene resin, acrylonitrile butadiene chlorinated polyethylene resin	
: general	55
: reinforced with glass fiber	80
polypropylene	
: general	105, (85) ³⁾
: reinforced with glass fiber	110
denatured polyphenyle oxide	
: general	75
: reinforced with glass fiber	100
Polystyrene	50, (70) ¹⁾
polyacetal	
: general	100
: reinforced with glass fiber	120
polyamide	
: general	90
: reinforced with glass fiber	120
polycarbonate	
: general	110
: reinforced with glass fiber	120
polyethylene terephthalate	
: general	120
: reinforced with glass fiber	130
polybutylene terephthalate	
: general	120
: reinforced with glass fiber	135
heat resistant polyethylene terephthalate film	135
fluorinated polyvinylidene compound for insulated conductors, polychlorotrifluoroethylene (ethylene-trifluoride resin), ethylene-tetrafluoroethylene copolymer for insulated conductors	150
tetrafluoroethylene hexafluoropropylene resin	200
polytetrafluoroethylene(ethylene-tetrafluoride), perfluoroalkoxy compound for insulated conductors	250
aramide(aromatic polyamide paper)	220
Polysulfone	140, (150) ²⁾
polyethylene naphthalate	155
polyallylate	
: general	120
: reinforced with glass fiber	130

Notes : 1) Values apply to capacitor dielectrics.

2) Values apply to thermal insulating material

3) Values apply to materials with a thickness of less than 0.8 mm

4) Inorganic materials

Inorganic materials

Material	Permission temperature limit (°C)
glass fiber (only alkaline free)	300
lead glass	380
borosilicate glass	490
quartz glass	800
ceramic	800, (1000) ¹⁾

Note: 1) Value apply to materials used as electric heating elements

Rubber compounds

Material	Permission temperature limit (°C)
----------	-----------------------------------

National Differences			
Clause	Requirement – Test	Result – Remark	Verdict
	natural rubber, polyurethane rubber, ebonite	60	
	nitrile rubber, styrene butadiene rubber, chloroprene rubber	75	
	butyl rubber	80	
	ethylene propylene (diene) rubber, chlorosulfonated polyethylene rubber	90	
	silicone rubber	180, (200) ¹⁾	

Note : 1) Value apply to thermal insulating material and sealing compounds for sheathed heating elements.

Sleeves, Cloth, Tapes and like

Material	Impergnat or coating	Permission temperature limit (°C)
rayon, cellulose acetate, vinylon	adhesive, oil varnish	105
paper, cotton fabric, silk fabric, polyamide, polyester fabric, polyester nonwoven fabric	oil varnish	105
polyester fabric, polyester nonwoven fabric	alkyd resin varnish	120
glass fabric	(ditto)	130
paper	Iso or terephtalate alkyd resin varnish, epoxy resin varnish, alkyd resin varnish	105
polyester fabric, polyester nonwoven fabric	(ditto)	120
glass fabric, aramide paper	Iso or terephtalate, alkyd resin varnish, epoxy resin varnish, silicone resin varnish, silicone rubber	155 180
vulcanised fiber		105
heat resistant fiber		120

National Differences				
Clause	Requirement – Test	Result – Remark	Verdict	
5.1.3	Add the following NOTE Note: Note that domestic three-phase power distribution systems have many delta connections, in which case tests should be performed using IEC 60990:1990 Figure 13 test circuitry.	Single phase	N/A	
5.1.6	Replace Table 5A of this Sub-Clause by:	Replaced.	P	
Table 5A	Table 5A – Maximum current			
	Type of equipment	Terminal A of measuring instrument connected to:	Maximum TOUCH CURRENT mA r.m.s. ¹⁾	Maximum PROTECTIVE CONDUCTOR CURRENT
	ALL equipment	Accessible parts and circuits not connected to protective earth	0,25	-
	HAND-HELD	Equipment main protective earthing terminal (if any) CLASS I EQUIPMENT	0,75	-
	MOVABLE (other than HAND-HELD, but including TRANSPORTABLE EQUIPMENT		3,5	-
	STATIONARY, PLUGGABLE TYPE A		3,5	-
	ALL other STATIONARY EQUIPMENT not subject to the conditions of 5.1.7 - subject to the conditions of 5.1.7		3,5 -	- 5 % of input current
	HAND-HELD	Equipment main protective earthing terminal	0,5	-
	Others	(if any) CLASS 0I EQUIPMENT	1,0	-
	¹⁾ If peak values of TOUCH-CURRENT are measured, the maximum values obtained by multiplying the r.m.s. values by 1,414.			
6	Add the following after NOTE1 of this Sub-Clause. Refer to the accompanying document, JB, for details concerning appropriate additional measures, Replace “IEC 60664-1” to “JIS C 0664 in note 4	Not subject connected to telecom	N/A	
7	Replace “IEC 60664-1” to “JIS C 0664:2003 of this NOTE 3	Not subject connected to calbe distribution system	N/A	

National Differences			
Clause	Requirement – Test	Result – Remark	Verdict
7.2	<p>Add the following</p> <p>However, when all of the following criteria are satisfied, the separation requirement and test in 6.2.1 a), b) and c) shall not be applied to the cable distribution system.</p> <ul style="list-style-type: none"> - the applicable circuit is a TNV-1 circuit. - the applicable circuit's common side or grounding side is connected to the coaxial cable shielding, and to all accessible parts and circuits (SELV circuits, accessible metal parts, and limited current circuits also applicable if they exist) - the external conductor of the coaxial cable is intended to be connected to the grounding wire used for building wiring. 		N/A
Annex G 2.1	Replace "IEC 60664-1" to "JIS C 0664:2003"	Not considered the alternative method	N/A
Annex G 6	Replace "IEC 60664-1" to "JIS C 0664:2003"		N/A
Annex N	Add Note Note: ITU-T Recommendation K.17:1996 has been abolished and replaced with ITU-T Recommendation K.44:2003, K.45:2003.		N/A
	Note: The ITU-T Recommendation K.21:1996 test circuit was replaced with K.44:2003 in July 2003.		N/A
Annex P	<p>Add the following terms.</p> <p><u>JIS C 5101-14:1998 Fixed capacitors for use in electronic equipment -- Part 14: Type-specific standards: Fixed capacitors for electromagnetic interference suppression in electrical power supply</u></p> <p>Fixed capacitors for use in electronic equipment –Part 14: Sectional specification: Fixed capacitors for electromagnetic interference suppression and connection to the supply mains</p>	Add, No such capacitor	N/A
	Replace "IEC 60065:1998" to "IEC 60065:2001"	Replaced, no A/V device	N/A
	Add the following terms. JIS C 6802:2005	Considered	P
	Add the following terms. JIS C 6803:2006 2004.	Considered	P
	Add the following terms. JIS C 8303:2007	Considered	P
	Add the following terms. JIS S 0101:2000	Considered	P

National Differences			
Clause	Requirement – Test	Result – Remark	Verdict
	Add the following terms. ITU-T Recommendation K.44:2003 , Resistibility tests for telecommunication equipment exposed to overvoltages and overcurrents – Basic Recommendation.	No TNV	N/A
	Add the following terms. ITU-T Recommendation K.45:2003 , Resistibility of telecommunication equipment installed in the access and trunk networks to overvoltages and overcurrents.	No TNV	N/A
Annex Q	Add the following terms. ITU-T Recommendation K.66:2004 , Protection of customer premises from overvoltages.	No TNV	N/A
Annex T	Replace “IEC 60529:1989” to “JIS C 0920:2003		N/A
Annex W.1	Add following. Equipment, Class 0I	Class II	N/A

National Differences			
Clause	Requirement – Test	Result – Remark	Verdict
Annex JA	Add Annex JA (Document shredding machines) Document shredding machines shall also comply with the requirements of this annex except those of STATIONARY EQUIPMENT used by connecting directly to an AC MAINS SUPPLY of three-phase 200V or more.	See below	N/A
JA.1	<p>Markings and instructions</p> <p>In the easily visible part near the document-slot, by a method capable to make out clearly and not easily disappeared, and by easily understandable wording, shall indicate the symbol of;</p> <p></p> <p>and, also the following precautions for use; that use by an infant/child may cause a hazard of injury etc.;</p> <p>that a hand can be drawn into the mechanical section for shredding when touching the document-slot;</p> <p>that clothes can be drawn into the mechanical section for shredding when touching the document-slot;</p> <p>that hairs can be drawn into the mechanical section for shredding when touching the document-slot;</p> <p>in case of equipment incorporating a commutator motor, that equipment may catch fire or explode by spraying of flammable gas.</p>	Added. Product is DC Power Supply Unit, not Paper Shredder.	N/A
JA.2	<p>INADVERTENT REACTIVATION</p> <p>Any safety interlock which can be operated by means of the test finger, Figure JA.1, is considered to cause reactivation of the hazard. Compliance is checked by inspection and, where necessary, by a test with the test finger, Figure JA.1.</p>	No safety interlock used	N/A

National Differences			
Clause	Requirement – Test	Result – Remark	Verdict

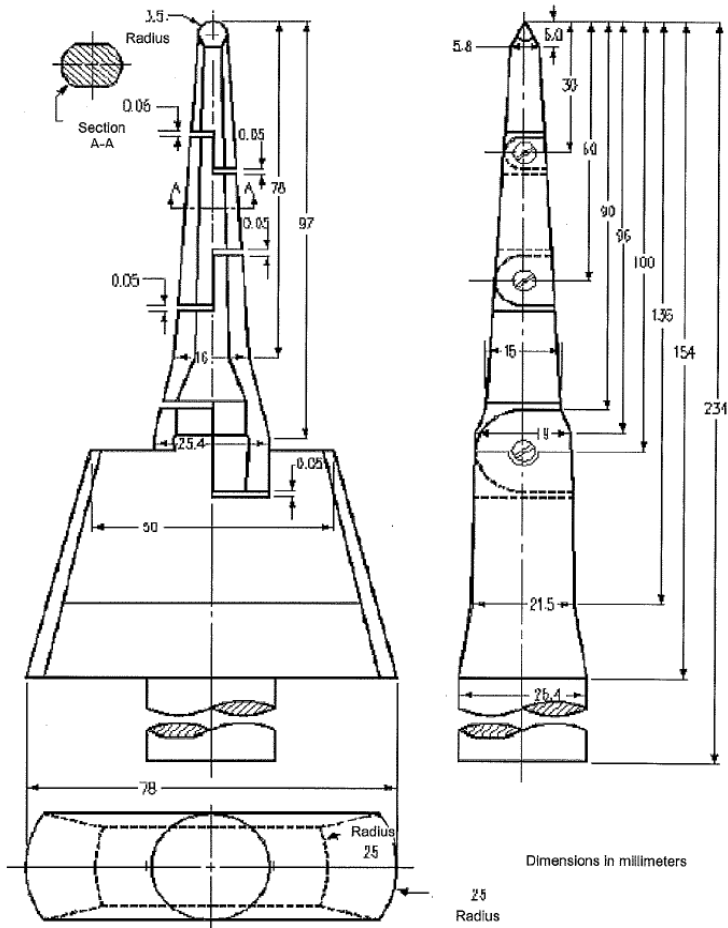
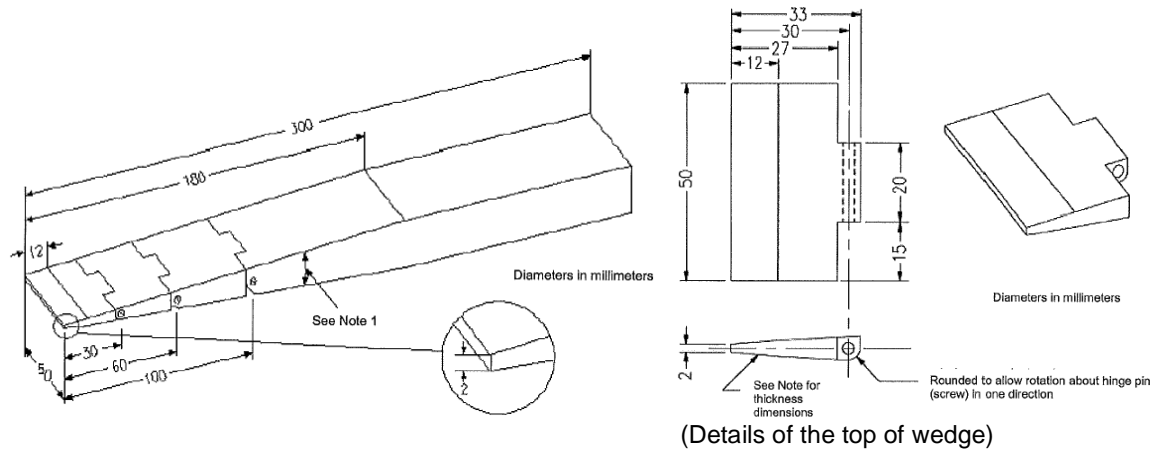

Figure JA.1 Test finger

National Differences			
Clause	Requirement – Test	Result – Remark	Verdict
JA.3	<p>ISOLATING SWITCH</p> <p>Document shredding machines shall incorporate an isolating switch complying with sub-clause 3.4.2 as the device disconnecting the power of hazardous moving parts. For this switch, two-position (single-use) switch or multi-position (multifunction) switch (e.g., slide switch) may be used.</p> <p>If two-position switch, the positions for “ON” and “OFF” shall be indicated in accordance with sub-clause 1.7.8. If multi-position switch, the position for “OFF” shall be indicated in accordance with sub-clause 1.7.8 and other positions shall be indicated with proper terms or symbols.</p> <p>Compliance is checked by inspection.</p>		N/A
JA.4	<p>PROTECTION IN OPERATOR ACCESS AREAS</p> <p>Any warning shall not be used instead of the structure for preventing access to hazardous moving parts.</p> <p>Document shredding machines shall comply with the following requirements.</p> <p>Push the test finger, Figure JA.1, into all openings in MECHANICAL ENCLOSURES without applying additional force. It shall not be possible to touch hazardous moving parts with the test finger. The document shredding machine is installed as intended, and all face of MECHANICAL ENCLOSURES are subjected to this test. Before testing with the test finger, remove the parts detachable without a tool.</p> <p>Push the wedge-probe, Figure JA.2, into the document-slot. And, against all directions of openings, if straight-cutting type, a force of 45 N shall apply to the probe, and 90 N if cross-cutting type. In this case, the weight of the probe shall not influence the test. Before testing with the test finger, remove the parts detachable without a tool. It shall not be possible to touch any hazardous moving parts, including the shredding roller or the mechanical section for shedding, with the probe.</p>	<p>Added.</p> <p>Product is DC Power Supply Unit, not Paper Shredder.</p>	N/A

National Differences			
Clause	Requirement – Test	Result – Remark	Verdict



Distance from the top	Thickness of probe
0	2
12	4
180	24

Note 1 - The probe shall be of changing the thickness linearly. However, the slope shall be changed at the respective points shown in the table.

Note 2 –The allowable dimensional tolerance of the probe is +/- 0.127 mm.

Figure JA.2 Wedge-probe

National Differences			
Clause	Requirement – Test	Result – Remark	Verdict
Annex JB (reference)	Add Annex JB (Current state and means of handling overvoltage and overcurrent in the installation environment) The objective of this reference is not to propose new technical standards for the device. As a means of reducing the possibility that voltages in excess of 1.5kV peak may be applied to the device, these specifications provide for matters that must be adhered to concerning the device on the premise that it is installed in an environment within which appropriate measures have been taken in accordance with “ ITU-T Recommendation K.11:1993 ”. However, since environments that are not commensurate with this K.11 are often discovered domestically, this document attempts to describe the preferred environment and demonstrate the means for developing the preferred installation environment, thus contributing to its enhancement.	No such installation requirement	N/A
JB.1	JB.1 Preferred installation environment		N/A
JB.2	Current state and means of handling overvoltage and overcurrent in the installation environment		N/A

National Differences			
Clause	Requirement – Test	Result – Remark	Verdict

Appendix	J3000 (H21) Special National conditions, National deviation and other information according to MITI Ordinance No. 85.		—
1	<p>General requirement</p> <p>When equipment provides with appliance inlet complying with JIS-C 8283-1(2008), soldered parts of appliance inlet is not applied by force during insert or removal of connector.</p> <p>This is not applied when inlet body is fixed itself and not fixed by solder.</p>	Inlet is fixed by adequate mechanical construction, not rely on soldering. Soldered parts of appliance inlet is not applied by force during insert or removal of connector	P
2	Requirement for equipment		—
2.1	<p>Electric heater</p> <p>When diode is used in parallel for adjustment of power, the equipment shall remain safe for operation under open condition of one diode.</p>	Not electric stove.	N/A
	The current rating of one diode shall be more than main current. The diodes connected in parallel are same type.		N/A
	The heating test specified by clause 11 of JIS C 9335-2-30(2006) under open condition of one diode shall comply with the requirements.		N/A
2.2	<p>Electric heater with glowing heating elements</p> <p>Surface treatment by paint or adhesive on protective frame or protective mesh shall not be used.</p> <p>Caution marking like below shall be on</p> <ul style="list-style-type: none"> - easily visible place of the equipment or - Instruction manual <p>「注意 当該機器から、使用初期段階で揮発性有機化合物およびカルボニル化合物が最も放散するおそれがあるため、その際には十分換気を行うこと。」</p>	Not electric stove.	N/A
3	Components used in equipment	No relevant equipment or component.	N/A
3.1	<p>Motor capacitors used in air conditioner, electric washing machine, refrigerator or electric freezer shall be comply with</p> <ul style="list-style-type: none"> - capacitors with protective elements or protective mechanism complying with JIS C 4908(2007) - P2 capacitor complying with IEC 60252-1(2001) <p>Capacitor complying with below is acceptable</p>	Not such equipment.	N/A
	Enclosed by metal or ceramic		N/A
	No non-metallic materials within 50 mm from capacitor surface		N/A
	Non-metallic material within 50 mm from capacitor surface comply with needle frame test of JIS C 9335-1(2003), Annex E		N/A

National Differences			
Clause	Requirement – Test	Result – Remark	Verdict
	Non-metallic material within 50 mm from capacitor surface comply with V-1 test of JIS C 60965-11-10(2006).		N/A
3.2	<p>Plug directly inserted to outlet used refrigerator or electric freezer.</p> <p>Shall comply with</p> <ul style="list-style-type: none"> - Face contact with outlet shall have CTI with more than 400 according to JIS C 2134(2007) or - Supporting material of blades shall comply with glow wire test by temperature of 750°C according to JIS C 60695-2-11(2004) or JIS C 60695-2-12(2004). <p>Materials having glow wire frame temperature of 775 °C are acceptable.</p>	Not such equipment.	N/A



National Differences			
Clause	Requirement – Test	Result – Remark	Verdict

**ATTACHMENT TO TEST REPORT IEC 60950-1
CHINA NATIONAL DIFFERENCES**

Information technology equipment – Safety –
PART 1: GENERAL REQUIREMENTS



Differences according to.....: GB4943.1-2011

1.1.2	GB 4943.1-2011 applies to equipment for use at altitudes not exceeding 5000m above sea level, primarily in regions with moderate or tropical climates. Amend the third dashed paragraph of 1.1.2 as: — — equipment intended to be used in vehicles, on board ships or aircraft, at altitudes greater than 5000m;	Amended. Considered.	P
1.4.5	After the third paragraph, add a paragraph: If the equipment is intended for direct connection to an AC mains supply, the tolerances on RATED VOLTAGE shall be taken as +10%,-10% unless a wider tolerance is declared by the manufacturer. The first dash paragraph "-the RATED VOLTAGE is 230V single -phase or 400V three-phase, in which case the tolerance shall be taken as +10% and -10%" of IEC 60950-1:2005 is deleted in GB 4943.1-2011	Added. Considered.	P
1.4.12.1	T _{ma} in clause 1.4.12.1 amended as: T _{ma} : is the maximum ambient temperature permitted by the manufacturer's specification, or 35 °C, whichever is greater. Add note 1: For equipment not to be operated at tropical climatic conditions, T _{ma} : is the maximum ambient temperature permitted by the manufacturer's specification, or 25 °C, whichever is greater. Add note 2: For equipment is to be operated at 2000m-5000m above sea leave, its temperature test conditions and temperature limits are under consideration.	The maximum ambient temperature permitted by the manufacturer's specification as 25 °C	P
1.5.2	Add a note behind the first break off section in Clause 1.5.2: A component used shall comply with related requirements corresponding altitude of 5000m.	Added. Shall be evaluated during national approval.	N/A
1.7	Add one paragraph before the last paragraph: The required marking and instruction should be given in normative Chinese unless otherwise specified.	Added. Shall be provided accordingly during national approval.	N/A

National Differences			
Clause	Requirement – Test	Result – Remark	Verdict
1.7.1	<p>Based on the AC mains supply of China, the RATED VOLTAGE should be 220V (single phase) or 380V (three-phases) for single rated voltage, for RATED VOLTAGE RANGE, it should cover 220V or 380V (three-phases), for multiple RATED VOLTAGES, one of them should be 220V or 380V (three-phases) and set on 220V or 380V (three-phases) when manufactured.</p> <p>And the RATED FREQUENCY or RATED FREQUENCY RANGE should be 50Hz or include 50Hz.</p>	<p>Considered. See section “copy of marking plate” in IEC 60950-1 test report.</p>	P
1.7.2.1	<p>Add requirements of warning for equipment intended to be used at altitudes not exceeding 2000m or at non-tropical climate regions: For equipment intended to be used at altitude not exceeding 2000m, a warning label containing the following or a similar appropriate wording, or a symbol as in annex DD shall fixed to the equipment at readily visible place. "Only used at altitude not exceeding 2000m."</p>  <p>For equipment intended to be used in not-tropical climate regions, a warning label containing the following or a similar appropriate wording, or a symbol as in annex DD shall fixed to the equipment at readily visible place. "Only used in not-tropical climate regions."</p>  <p>If only the symbol used, the explanation of the symbol shall be contained in the instruction manual. The above statements shall be given in a language acceptable to the regions where the apparatus is intended to be used.</p>	<p>Added. Warnings shall be provided accordingly during national approval.</p>	N/A
2.7.1	<p>Amended the first paragraph as: Protection in PRIMARY CIRCUITS against overcurrent short-circuits and earth faults shall be provided as an integral part of the equipment except special provisions. And the protective device shall meet the requirement of Clause 5.3. Delete note of Clause 2.7.1.</p>	<p>Amended and deleted. Compliance checked.</p>	P

National Differences			
Clause	Requirement – Test	Result – Remark	Verdict
2.9.2	<p>First section of Clause 2.9.2 amended as two sections:</p> <p>Where required by 2.9.1, 2.10.8.3, 2.10.10 or 2.10.11, humidity conditioning is conducted for 120 h in a cabinet or room containing air with ambient temperature 40 ± 2 °C and a relative humidity of $(93\pm 3)\%$. During this conditioning the component or subassembly is not energized. For equipment not to be operated at tropical climatic conditions, Where required by 2.9.1, 2.10.8.3, 2.10.10 or 2.10.11, humidity conditioning is conducted for 48 h in a cabinet or room containing air with a relative humidity of $(93\pm 3)\%$. The temperature of the air, at all places where samples can be located, is maintained within 2 °C of any convenient value between 20 °C and 30 °C such that condensation does not occur.</p> <p>Due to pretreatment of equipment operated at high altitude area is humidity conditioning withstand hot shock, specific requirements are to be considered.</p> <p>Add note: For equipment to be operated at 2000 m - 5000m above sea level, assessment and requirement of humidity conditioning for Insulation material properties are considered.</p>	See sub-clause 2.9.2 in the report.	P
2.10.3.1	<p>Amend the third paragraph of Clause 2.10.3.1 to be:</p> <p>These requirements apply for equipment to be operated up to 2000 m above sea level. For equipment to be operated at more than 2000 m above sea level and up to 5000m above sea level, the minimum CLEARANCE shall be multiplied by the factor 1.48 corresponding altitude of 5000m given in Table A.2 of IEC 60664-1. For equipment to be operated at more than 5000 m above sea level, the minimum CLEARANCE shall be multiplied by the factor given in Table A.2 of IEC 60664-1. Linear interpolation is permitted between the nearest two points in Table A.2. The calculated minimum CLEARANCE using this multiplication factor shall be rounded up to the next higher 0,1 mm increment.</p>	Amended. Shall be evaluated during national approval.	N/A
2.10.3.3& 2.10.3.4	Add "(applicable for altitude up to 2000m)" in header of Table 2K、 2L and 2M.	Added.	P

National Differences			
Clause	Requirement – Test	Result – Remark	Verdict
2.10.3.4	Add a new section above Table 2K and in Clause 2.10.3.4: Minimum CLEARANCES determined by above rules apply for equipment to be operated up to 2000m above sea level. For equipment to be operated at 2000 m - 5000m above sea level, the minimum CLEARANCE shall be multiplied by the factor 1.48 corresponding altitude of 5000m given in Table A.2 of GB/T16935.1 (IEC 60664-1). For equipment to be operated at more than 5000 m above sea level, the minimum CLEARANCE shall be multiplied by the factor given in Table A.2 of GB/T16935.1.	Added. Shall be evaluated during national approval.	N/A
3.2.1.1	Add a paragraph before the last paragraph: Plugs connected to AC mains supply shall comply with GB 1002 or GB 1003 or GB/T 11918 as applicable.	Added. No power supply cord provided.	N/A
4.2.8	Clause 4.2.8 cathode ray tubes quoted Clause 18 of GB8898-2011. Delete note of Clause 4.2.8.	No CRT.	N/A
Annex E	Last section of Annex E amended as: For comparison of winding temperatures determined by the resistance method of this annex with the temperature limits of Table 4B, 35 °C shall be added to the calculated temperature rise. And add note: for equipment not to be operated at tropical climatic conditions, 25 °C shall be added to the calculated temperature rise to compare with the temperature of Table 4B.	Amended.	N/A
Annex G.6	Change the second section of Clause G.6 to be: For equipment to be operated at 2000 m - 5000m above sea level, the minimum CLEARANCE shall be multiplied by the factor 1.48 corresponding altitude of 5000m given in Table A.2 of GB/T16935.1. For equipment to be operated at more than 5000 m above sea level, the minimum CLEARANCE shall be multiplied by the factor given in Table A.2 of IEC 60664-1. Linear interpolation is permitted between the nearest two points in Table A.2. The calculated minimum CLEARANCE using this multiplication factor shall be rounded up to the next higher 0,1 mm increment.	Changed. The alternative method was not considered.	N/A
Annex BB (informative)	Amended as : The differences between Chinese national standards GB 4943.1-2011 and GB 4943-2001.	Amended.	P

National Differences			
Clause	Requirement – Test	Result – Remark	Verdict
Annex DD (normative)	<p>Added annex DD: Instructions for the new safety warning labels.</p> <p>DD.1 Altitude warning label</p>  <p>Meaning of the label: Evaluation for apparatus only based on altitude not exceeding 2000m, therefor it's the only operating condition applied for the equipment .There may be some potential safety hazard if the equipment is used at altitude above 2000m .</p> <p>DD.2 Climate warning label</p>  <p>Meaning of the label: Evaluation for apparatus only based on temperate climate condition, therefor it's the only operating condition applied for the equipment .There may be some potential safety hazard if the equipment is used in tropical climate region.</p>	Added. Shall be provided accordingly during national approval.	N/A
Annex EE (informative)	Added annex EE: Illustration relative to safety explanation in normative Chinese, Tibetan, Mongolian, Zhuang Language and Uighu.	Added. Shall be provided accordingly during national approval.	N/A
Other amend-ments	In accordance with the relevant CTL decisions and the amendments of IEC 60950-1, the specific requirements or mistakes in IEC standard are corrected or editorially modified in this part, Including clause 1.7, 2.1.1.7, 2.9.2, Table 2H, Figure 2H, F.8, F.9, M.3 and Annex U.	Modified.	P
Quoting standards and reference documents	<p>The principles of quoting and referring to other standards in Annex P and reference documents of IEC 60950-1 are as follows:</p> <p>If the date of the reference document is given, only that edition applies, excluding any subsequent corrigenda and amendments. However, parties to agreements based on this part are encouraged to investigate the possibility of applying the most recent editions of the reference documents. For undated references, the latest edition of the referenced document applies, including any corrigenda and amendments.</p> <p>For the usage of international standards in Chinese national standards and industry standards is various, in the aim of achieving easy operation and based on the requirements of GB/T 1.1 and GB/T 20000.2, when quoting an entire international standard in the normative quoting files and reference documents of Annex P of this part, the principles of quotation are as follows:</p>	Considered.	P

National Differences			
Clause	Requirement – Test	Result – Remark	Verdict
	<p>- If there is no national standard or industry standard corresponding to the international standard, then the international standard is quoted;</p> <p>- If there is national standard or industry standard corresponding to the international standard, then either the national or industry standard is quoted;</p> <p>- If the date of the national standard or industry standard is not given, the latest edition of the standard applies;</p> <p>- The national standard or industry standard number, corresponding international standard number and the consistency level code should be identified in parentheses behind the listed national standard or industry standard.</p> <p>When quoting several chapters or clauses of the international standard, the principles of quotation are as follows:</p> <p>- If there is no national standard or industry standard corresponding to the international standard, then the international standard is quoted;</p> <p>- If there is national standard or industry standard corresponding to the international standard, then either the national or industry standard is quoted.</p> <p>Meanwhile, in order to retain the relevant information on international standards, informative annex CC is increased, which gives the table about the comparison of the normative quoting files and reference documents in IEC 60950-1: 2005 and GB 4943.1-2011.</p>		

Product: Switching Power Supply

Type Designation: FYxxxxyyy



Figure 1. front view



Figure 2. back view

Product: Switching Power Supply

Type Designation: FYxxxxyyy

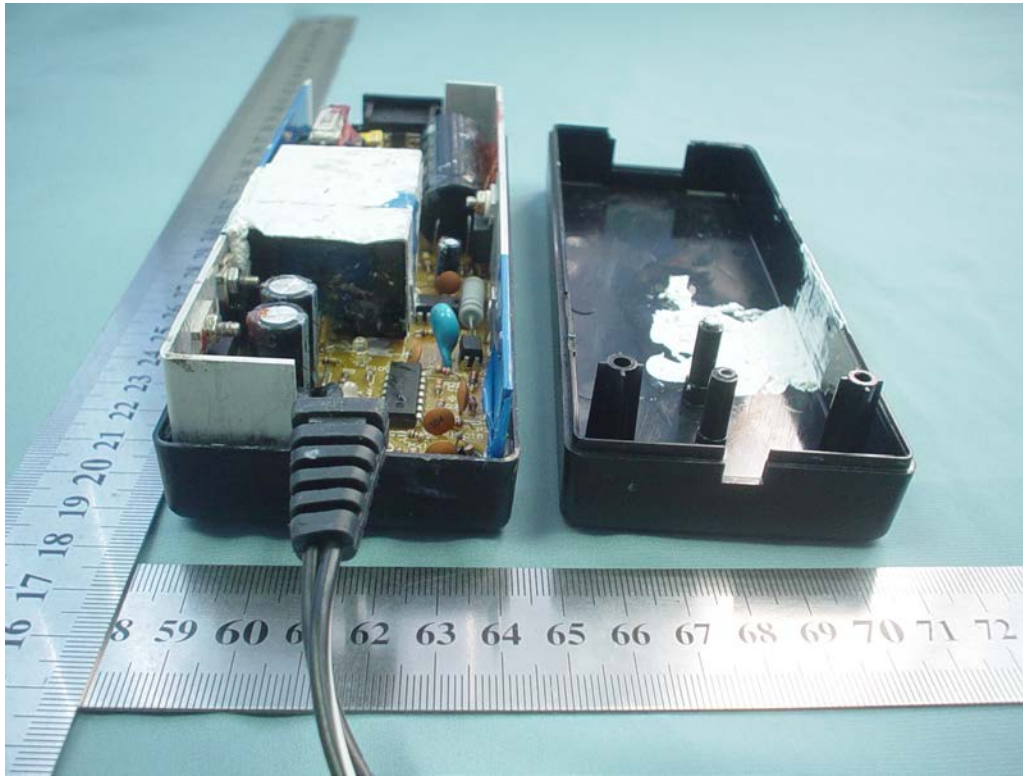

Figure 3. internal view



Figure 4. top view internal circuits

Product: Switching Power Supply

Type Designation: FYxxxxxxx

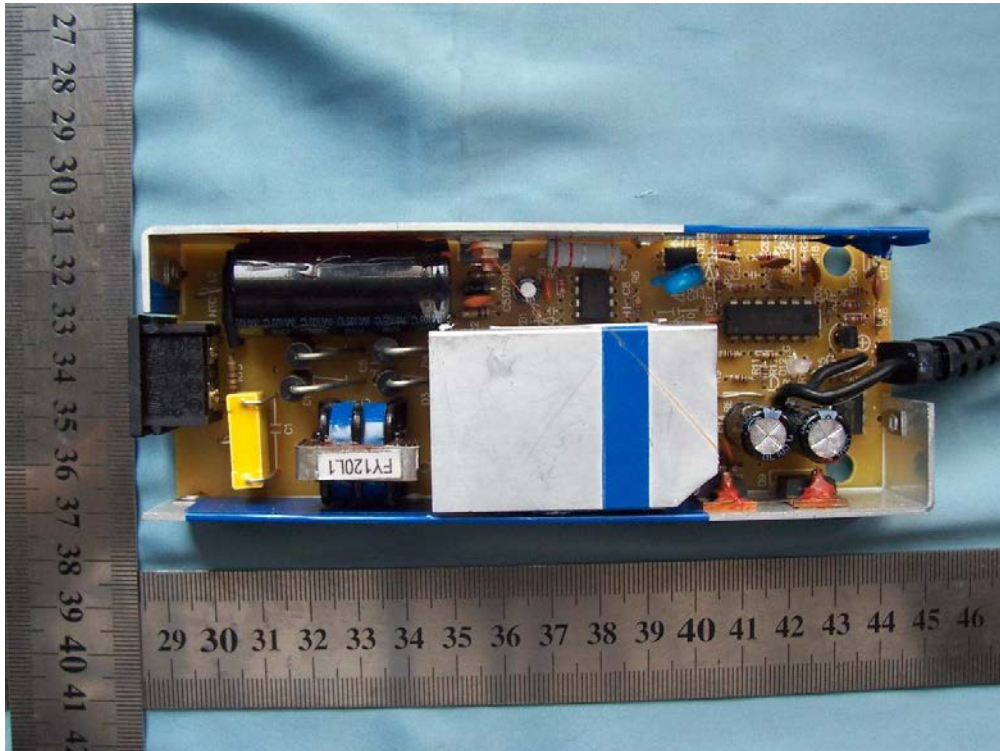

Figure 5. front view of PCB

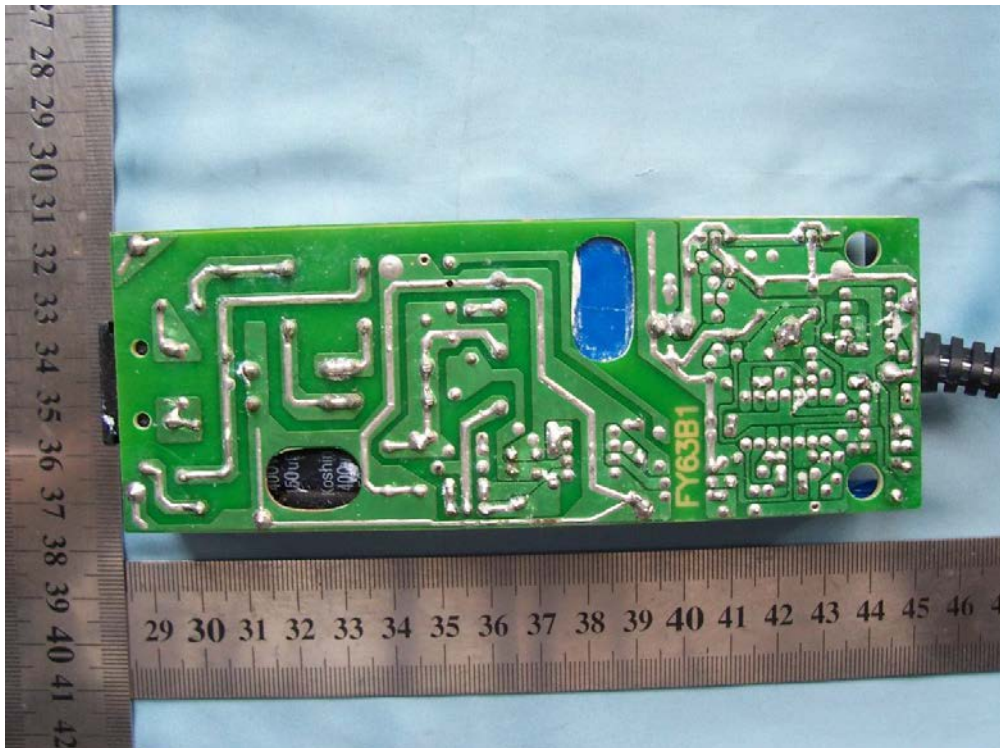

Figure 6. back view of PCB

Product: Switching Power Supply

Type Designation: FYxxxxyyy

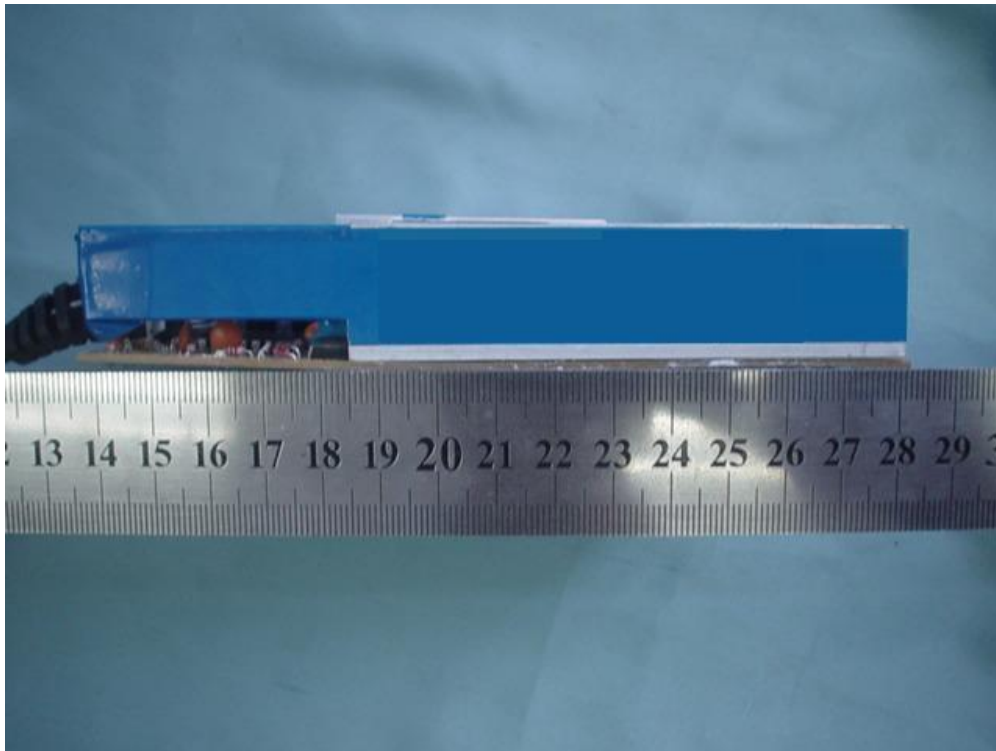

Figure 7. heat-sink of primary circuit

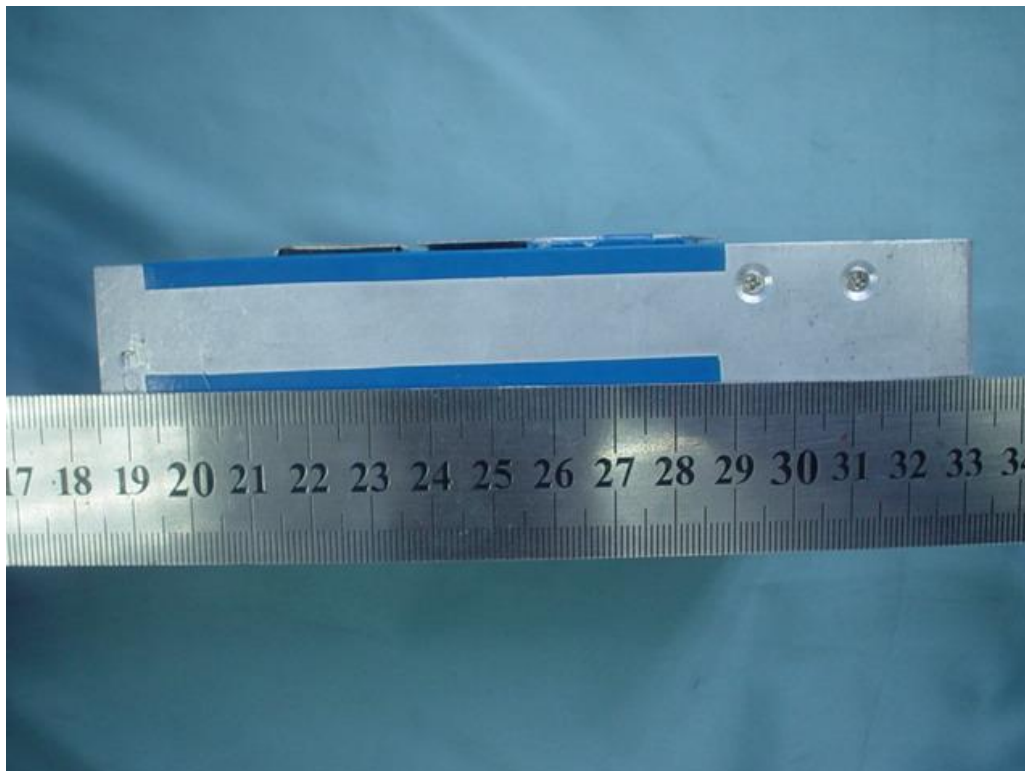

Figure 8. heat-sink of secondary circuit

Product: Switching Power Supply

Type Designation: FYxxxxyyy

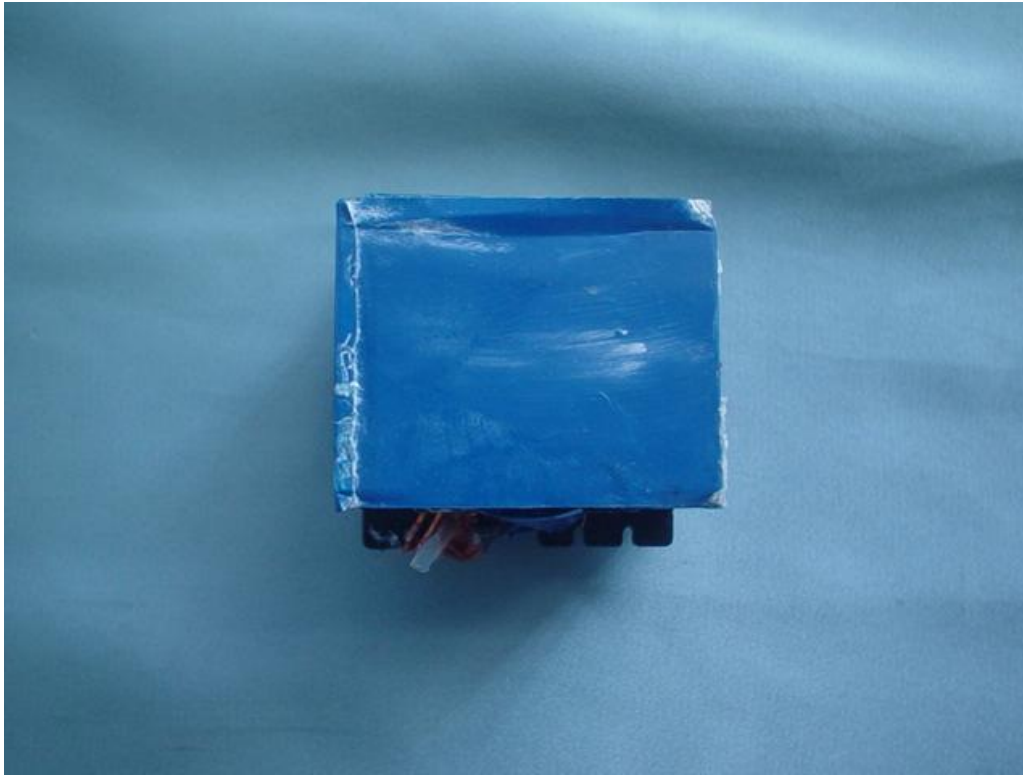

Figure 9. top view of transformer

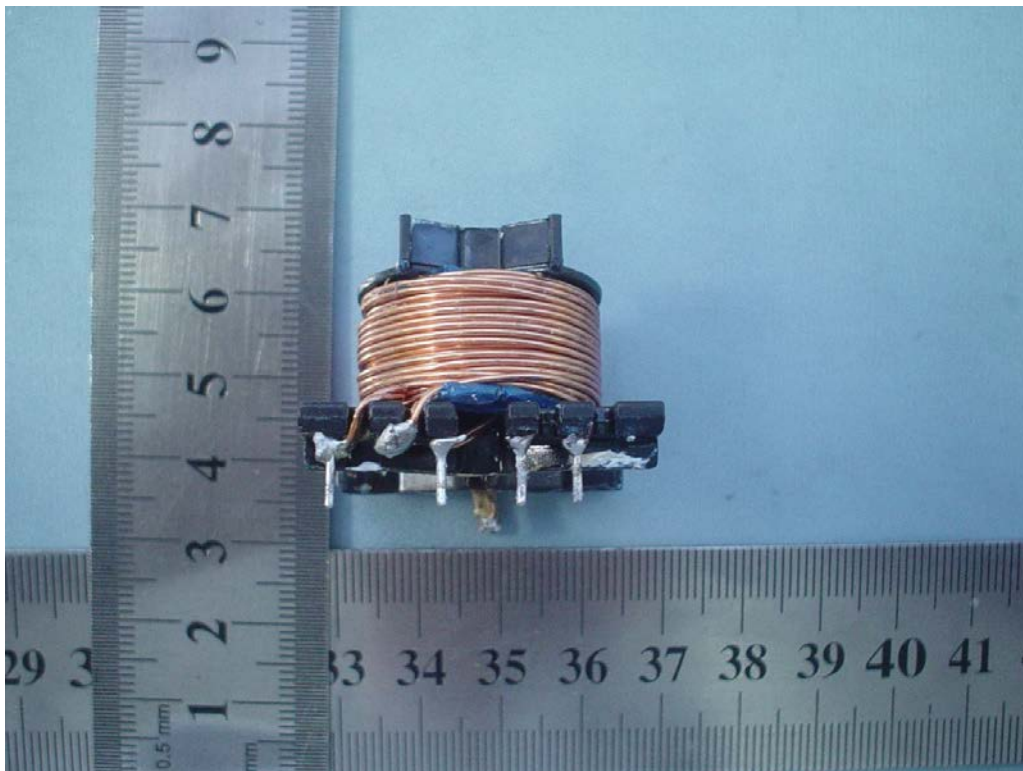

Figure 10. primary winding

Product: Switching Power Supply

Type Designation: FYxxxxyy



Figure 11. secondary winding

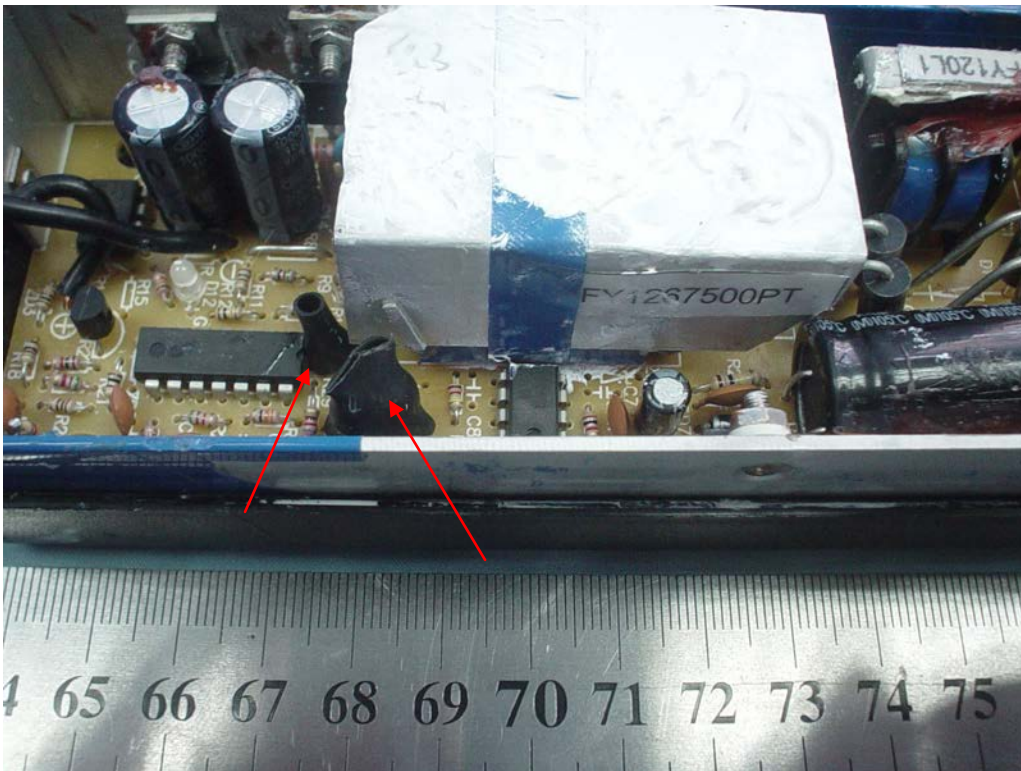

Figure 12. heat shrinkable tube on C9 and C11

Product: Switching Power Supply

Type Designation: FYxxxxxxx

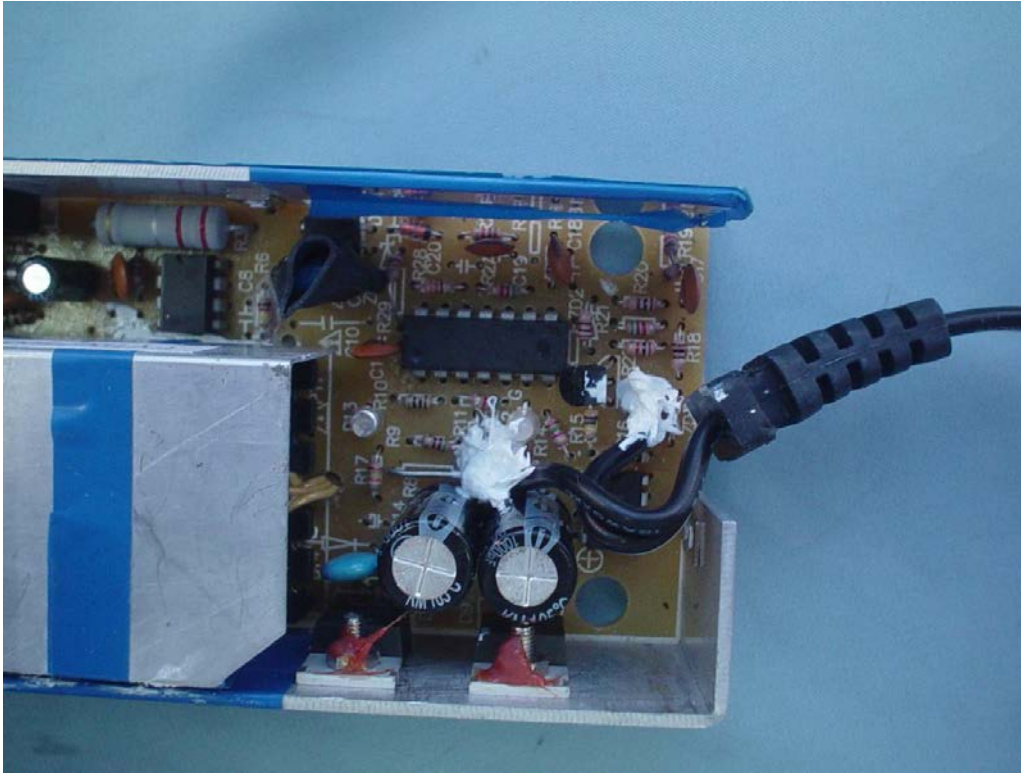

Figure 13. glue for fixing output wire