

User Guide

HOLSEM-A5 LED DISPLAY

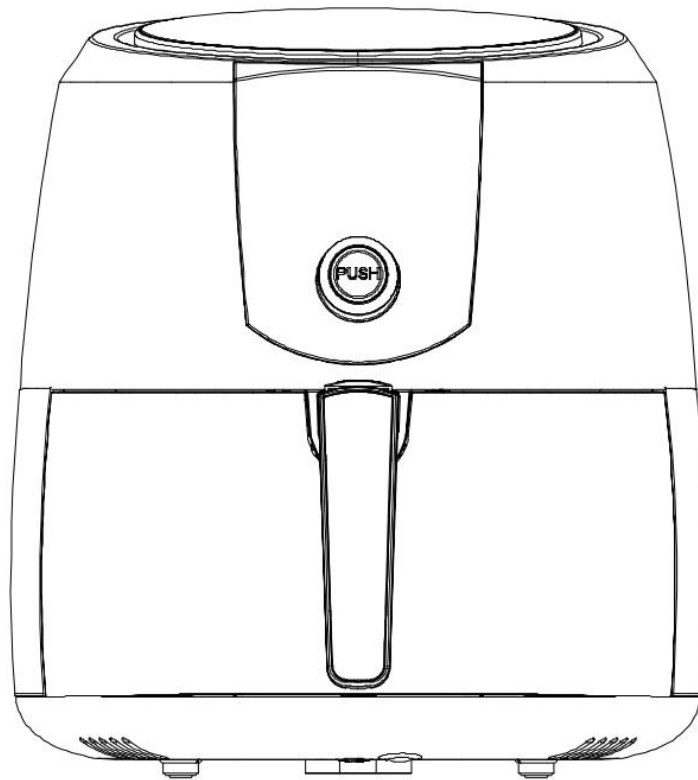

Note:

Please read carefully the instruction manual before using the appliance. Keep the manual for reference in future.

Your easy and healthy cooking experience starts from here.

Product Structure Diagram:

- ① Fry basket
- ② Protective cover
- ③ Push-release button
- ④ Handle bar
- ⑤ Fry pot
- ⑥ Upper Housing
- ⑦ Air inlet
- ⑧ Control panel
- ⑨ Control button (Push)
- ⑩ Air outlet
- ⑪ Power cable
- ⑫ Temperature button
- ⑬ Menu button
- ⑭ Keep warm button(2 Hours)
- ⑮ Timer button
- ⑯ Stop button

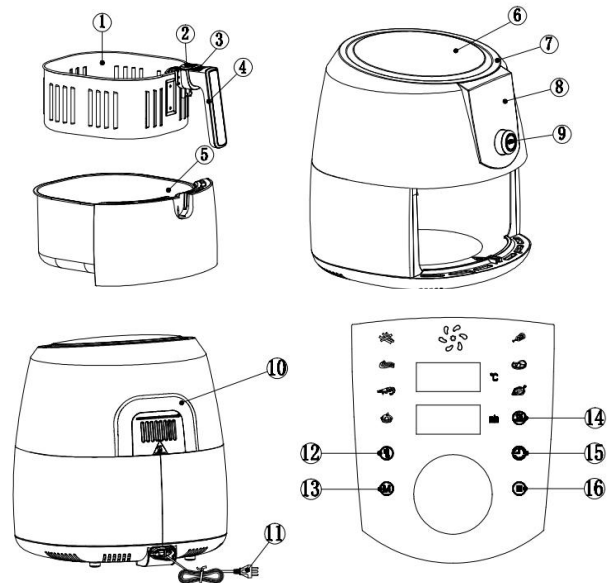

Cautions:

- Please carefully read the instruction manual, before using the appliance.
Keep the manual for reference in future;
- Never fill the Fry Pot with oil, or it may cause a fire hazard;
- The appliance main body contains electronic elements and heating elements. Do not put it in water or wash by water;
- Product surfaces get hot when the appliance is operating. Do not touch the hot surfaces. Operate by using handle or turning the knob.
- Do not cover the air inlet and outlet during the operating process. Do not touch the inside of the appliance to avoid burns and scalds;
- High temperature air will flow out from the outlet when the appliance is in use. Please keep safety distance. Do not touch the hot surfaces. Do not get close to the air outlet. When pulling out the fry pot, please be careful of high temperature air.

Security Warnings:

- Do not use the AC power other than 110V to avoid electric shock, fire and other accident;
- Please only plug to an wall outlet above 15A. To ensure continued protection against risk of electric shock, connect to properly grounded power socket only.
- Please keep the plug clean to avoid accident;
- Do not damage, strongly pull or twist the power cord. Do not use it to carry heavy loads, transform it, let the cord hang over edge of table or counter, or touch hot surfaces, to avoid electric shock, fire and other accidents. Damaged power cord must be repaired by professional maintenance technicians;
- Please do not plug and unplug with wet hands, otherwise it may cause electric shock;
- Plug tightly, otherwise, it may cause electric shock, short circuit, smoking, sparking and other dangers;
- Do not immerse the appliance, main body, cord or plug in water or other liquid, to protect against electrical shock and malfunction.
- Do not place the appliance in the presence of explosive and/or flammable fumes.
- Do not place the appliance on or near the flammable material, such as tablecloths, curtains and others, to avoid fire hazard;
- Be sure to use on a heat resistant and even surface, keep the appliance at least 30cm away from the wall, furniture and other flammables;
- Do not use the appliance for other than intended use;
- Physical or metal disabled persons or those lack in knowledge of this item must be guided by persons who have experience with this appliance and who will be responsible for their safety;
- Do not allow children to play with the socket or plug to avoid electric shock;
- Keep the appliance away from children to avoid scalding, electric shock and/or other injuries; close supervision is necessary when the appliance is used by or near children;
- This appliances is intended for Household Use Only.

WARRANTY

This product is warranted against defects in materials and workmanship for 1 year from the date of purchase when used in accordance with the instructions provided in the manual. This warranty does not cover damages or wear resulting from accident, misuse, abuse, commercial use, or unauthorized adjustment and/or repair.

Before the first use

1. Remove all packaging material.
2. Remove the stickers and labels from the appliance
3. Thoroughly clean the basket and the pan with hot water, some washing liquid and a non-abrasive sponge.
4. Wipe the inside and outside of the appliance with a moist cloth.

Preparing for use

1. Place the appliance on a stable and flat surface.

Note: Do not place the appliance on non-heat-resistant surface. The appliance works with good air circulation so keep it away from hot surface, and any combustible materials.

2. Place the basket in the pan properly - you will hear click sound. Slide the pan back to the appliance.

Note: This appliance works with hot air. Don not fill the pan with oil or frying fat.

Do not put anything on top of the appliance. This disrupts the airflow and affects the hot air frying result.

Using the appliance



1. Plug in the mains plug.

2. Preheating: Press the PUSH button. Then press the Timer button . Rotate the knob to left to set the preheating time to 3 minutes. Press the PUSH button again to start the preheating.

3. When the timer counts down to 0, carefully pull the fry pot out of the appliance, place the ingredients inside the fry basket (Attention: do not exceed the maximum line); well connect the fry basket with fry pot, and then slide the pan back to the appliance.

Note: Never use the pan without the basket in it.

Note: Do not touch the pan while cooking and some time after cooking, as the pan gets very hot. Only hold the pan by the handle.

4. Cooking: Press the “PUSH” button. Press menu button , then rotate the knob to scroll through the preset settings. Press the temperature and/or timer button , rotate the knob to left for decreasing temperature /time, to right for increasing temperature /time.

Note: To cancel all setting: press the stop button .

5. After setting, press the PUSH button to start cooking.

Note: To stop cooking process: press  button. The fan will continue spinning for 20 seconds.

6. When cooking time counts down to zero, the appliance beeps to signal that the cooking cycle is complete. The fan will continue spin for 20 seconds. Pull the pan out of the appliance and place it on a heat-resistant surface.

7. Check if the ingredients are ready. If the ingredients are not ready yet, slide the pan back into the appliance and set for additional cooking time of a few more minutes.

8. If the ingredients are ready, carefully pull out the pan, and place it on a heat-resistant surface. Press the basket release button, and lift the basket out of pan to remove the ingredients.

Note: Don not turn the basket upside down with the pan still attached to it, as any excess oil that has been collected on the bottom of the pan will leak to the ingredients.

9. Empty the basket into a bowl or onto a plate. When a batch of ingredients are ready, the appliance is instantly ready for preparing the next batch.

Tips:

- *Add some oil on the ingredients for a crispy result..*
- *Shaking ingredients halfway during the preparation time optimizes the end result and can help prevent unevenly fried ingredients. To shake the ingredients, pull the pan out of the appliance by the handle and shake it. Then slide the pan back into the appliance. Do not press the basket release button during shaking.*

Care and Maintenance

Note: Clean the appliance after every use.

1. Before cleaning, turn the timer to 0, unplug the appliance and wait for the appliance to cool down. Don't touch the surface before it cools down.
2. Do not immerse the device in water or any other liquid. The device is not dishwasher proof.
3. Clean the surface of the fryer pot and basket with hot water, some dish washing liquid and a non-abrasive sponge.

Tip: If dirt is stuck to the basket or the bottom of the pan, fill the pan with hot water with some dish washing liquid. Put the basket in the pan and let the pan and basket soak for about 10 minutes.

4. Used damp cloth to wipe the surface of the fryer. Never use harsh and abrasive cleaners, metal kitchen utensils or abrasive cleaning materials, which damage the device.
5. If you do not plan to use the appliance for a long time, please clean it, and store it in a cool and dry place.

Technical Specifications:

Rated Voltage: 120V~

Rated Frequency: 60Hz

Rated Power: 1800W

Fry basket Capacity: 5.2L

Net Weight: 12.12 lbs

Adjustable Temperature range: 180-400°F

Timer range: 0-60 min

Product Size: 16.59 * 13.50 * 14.99 inch

Troubleshooting:

Problem	Possible Cause	Solution
Does not work	Power cord has not been inserted into the power socket	Closely insert the power cord into the grounded power socket.
	Did not set the cooking model	Press the model selection button to select appropriate cooking model, then press the ON/OFF button (PUSH button).
	Didn't press the ON/OFF button (PUSH button) after select cooking model.	Click the ON/OFF button (PUSH button).
Food is rare when time up	Too much food in the basket	Fry food in several batches
	Temperature set is too low	Set to an appropriate temperature, re-fry food.
	Cooking time is short	Set an appropriate cooking time, re-fry food.
Did not fry food evenly	Certain foods need to be shaken in the middle of cooking.	In the middle of cooking process, pull the pan out and shake it to separate the overlapping food material, then push the pan back to continue.
Fried food is not crispy	Some food materials have to be fried with oil	Brush a thin layer of oil on the surface of the food first, then start to fry.
Can not smoothly push the pan back to the appliance	The basket has too much food or materials are too heavy	The food material in the basket can not exceed the max line.
	The basket is not correctly placed in the pan.	Press the basket into the pan.
	Handle bar got stuck..	Place the handle bar in horizontal position.
Smoking	Frying oily food	Normal phenomenon.
	Fryer pan contains oil from last use	Please clean the pot and basket after each use.



Correct Disposal of this product:

This marking indicates that this appliance should not be disposed with other household wastes. To prevent possible harm to the environment or human health from uncontrolled waste disposal, recycle it responsibly to promote the sustainable reuse of material resources

HOLSEM

Your Safe is Our Priority

Add: 1045 E. Valley Blvd. A112, San Gabriel, CA 91776, United States

Email: customerservice@holsem.com