

GooLED

GooLED-NIC-8630 Pin Fin Heat Sink Φ 86.5mm for Nichia

Features VS Benefits

- * The GooLED-NIC-8630 Nichia Pin Fin LED Heat Sinks are specifically designed for luminaires using the Nichia LED engines.
- * Mechanical compatibility with direct mounting of the LED engines to the LED cooler and thermal performance matching the lumen packages.
- * For spotlight and downlight designs from 1,200 to 3,200 lumen.
- * Thermal resistance range R_{th} 2.5°C/W.
- * Modular design with mounting holes foreseen for direct mounting of Nichia COB series.
- * Diameter 86.5mm - standard height 50.0mm, Other heights on request.
- * Forged from highly conductive aluminum.

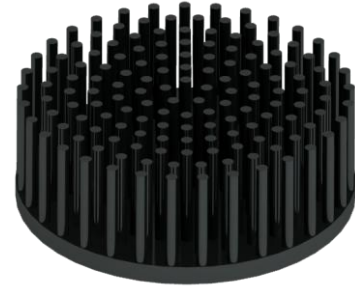

Zhaga LED engine and radiator assembly is a unified future international standardization

- * Below you find an overview of Nichia COB's and LED modules which standard fit on the Pin Fin LED Heat Sinks.
- * In this way mechanical after work and related costs can be avoided, and lighting designers can standardize their designs on a limited number of LED Pin Fin LED Heat Sink.

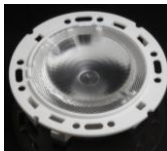

Nichia LED Modules directly Mounting Options

Nichia COB LED modules name:

- NFCWJ108B;
- NFCLJ108B;
- NFDWJ130B;
- NFDLJ130B;

With the Zhaga Book 3 Holders:

- TE LED Holder:2213580-2;
- Ideal Holder:50-2103NC;

Direct mounting with machine screws M3x6.5mm, green indicator marks.

- NFCWL036B;
- NFCLL036B;
- NFCWL060B;
- NFCLL060B;

With the Zhaga Book 3 Holders:

- Ideal Holder:50-2100NC;
- TE LED Holder:2213382-2;

Direct mounting with machine screws M3x6.5mm, Green indicator marks.

With the LEDiL products:

- Lena series: CN14xxx; C13xxx; C12xxx;
- Ronda series: FN15xxx-xx;

Nichia COB LED modules name:

- NVCWL024Z;
- NVCLL024Z;
- NVNW S007Z;
- NJCWS024Z;

With the Zhaga Book 11 Holders:

- BJB holder:47.319.6180.50;
- TE LED Holder:2213118-1;

Direct mounting with machine screws M3x8mm, Red indicator marks.

With the LEDiL products:

- Lena series: CN14xxx; C13xxx; C12xxx;
- Ronda series: FN15xxx-xx;

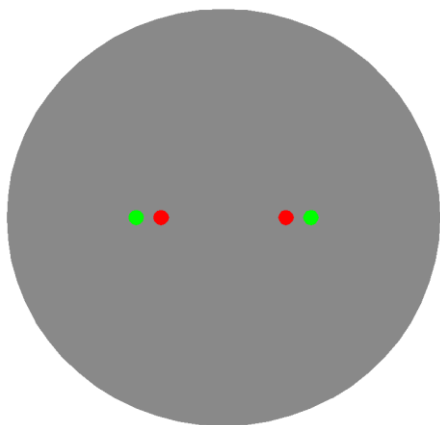

Mounting Options and Drawings & Dimensions

Example:GooLED-NIC-8630-B-1,2

Example:GooLED-NIC-86 **1** - **2** - **3**

1 Height (mm)

2 Anodising Color

B-Black

C-Clear

Z-Custom

3 Mounting Options - see graphics for details Combinations available

Ex.order code - 12

means option 1 and 2 combined

Notes:

- Mentioned models are an extraction of full product range.
- For specific mechanical adaptations please contact MingfaTech.
- MingfaTech reserves the right to change products or specifications without prior notice.

MOUNTING OPTION	Module type	Holder NO.	LEDiL products		THREAD	THREAD DEPTH	THREAD HOLE DISTANCE
			Lena series	Ronda series			
N	/	None	None	None	None	None	None
1	NVCWL024Z; NVCLL024Z; NVNWS007Z; NJCWS024Z;	BJB Holder 47.319.6180.50	CN14xxx; C13xxx; C12xxx;	FN15xxx-xx	M3	6.5mm	25.0mm/ 2-@180° (Zhaga book 11)
		TE Holder 2213118-1					
2	NFCWL036B; NFCLL036B; NFCWL060B; NFCLL060B;	Ideal Holder 50-2100NC					
		TE Holder 2213382-2					
2	NFCWJ108B; NFCLJ108B; NFDWJ130B; NFDLJ130B;	Ideal Holder 50-2103NC	M3	6.5mm	35.0mm/ 2-@180° (Zhaga book 3)		
		TE Holder 2213358-2					

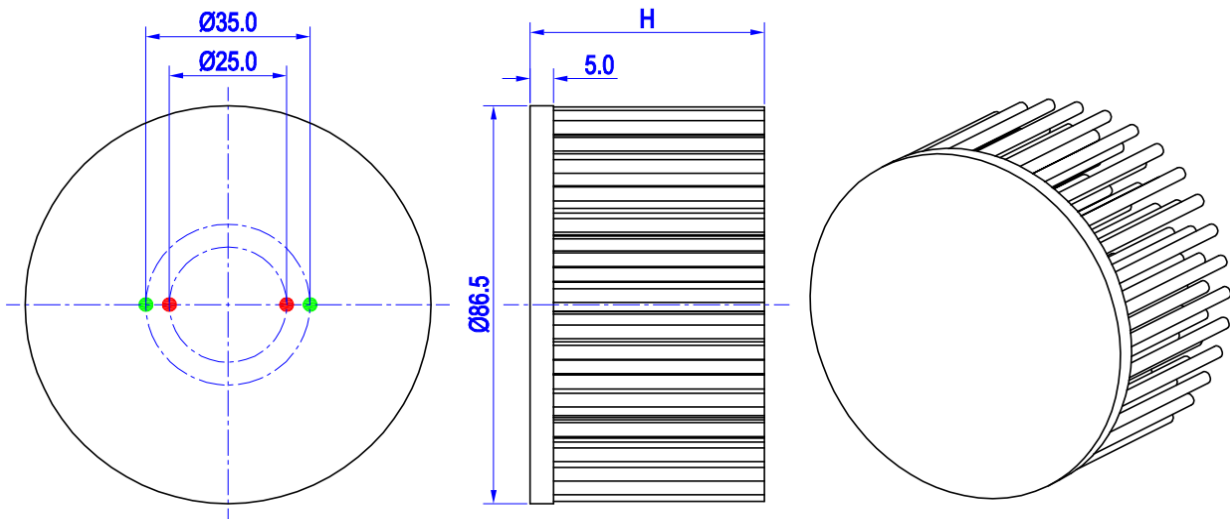



for

LED



GooLED

GooLED-NIC-8630 Pin Fin Heat Sink Φ 86.5mm for Nichia

The product data table

	Model No.	GooLED-NIC-8630
	Heatsink Size	Φ 86.5xH30mm
	Heatsink Material	AL1070
	Finish	Black Anodized
	Weight (g)	152.0
	Dissipated power (T _{hs-amb} ,50°C)	20.0 (W)
	Cooling surface area (mm ²)	48926
	Thermal Resistance (R _{hs-amb})	2.5 (°C/W)

The thermal data table

* Please be aware the dissipated power Pd is not the same as the electrical power Pe of a LED module.

*To calculate the dissipated power please use the following formula: Pd = Pe x (1-ηL).

Pd - Dissipated power ; Pe - Electrical power ; ηL = Light efficiency of the LED module;

Dissipated Power Pd(W)	Pd = Pe x (1-ηL)	Heat sink to ambient thermal resistance R _{hs-amb} (°C/W)	Heat sink to ambient temperature rise T _{hs-amb} (°C)
		GooLED-NIC-8630	
6.0		4.00	24.0
12.0		2.92	35.0
18.0		2.56	46.0
24.0		2.33	56.0
32.0		2.03	65.0

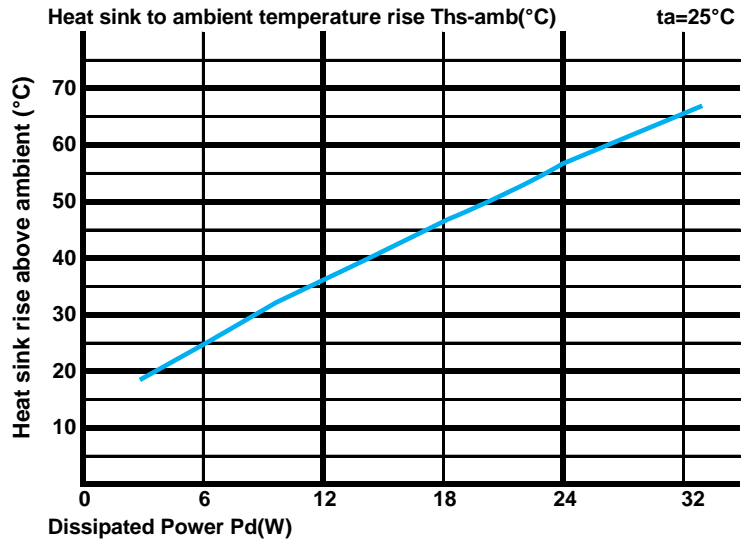

*The aluminum substrate side of the package outer shell is thermally connected to the heat sink via TIM (Thermal interface material).

MingFa recommends the use of a high thermal conductive interface between the LED module and the LED cooler.

Either thermal grease, A thermal pad or a phase change thermal pad thickness 0.1-0.15mm is recommended.

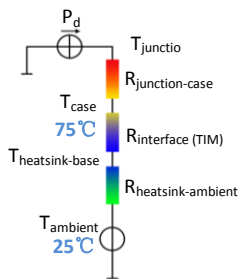

*Thermal resistance is a heat property and a measurement of a temperature difference by which an object or material resists a heat flow.

Geometric shapes are different, the thermal resistance is different. Formula: $\theta = (T_{hs} - T_a) / P_d$

θ - Thermal Resistance [°C/W]; T_{hs} - Heatsink temperature; T_a - Ambient temperature;

*The thermal resistance between the junction section of the light-emitting diode and the aluminum substrate side of the package outer shell is R_{junction-case}, the thermal resistance of the TIM outside the package is R_{interface (TIM)} [°C/W], the thermal resistance with the heat sink is R_{heatsink-ambient} [°C/W], and the ambient temperature is T_{ambient} [°C].

*Thermal resistances outside the package R_{interface (TIM)} and R_{heatsink-ambient} can be integrated into the thermal resistance R_{case-ambient} at this point. Thus, the following formula is also used:

$$T_{junction} = (R_{junction-case} + R_{case-ambient}) \cdot P_d + T_{ambient}$$