

MSNHJ35

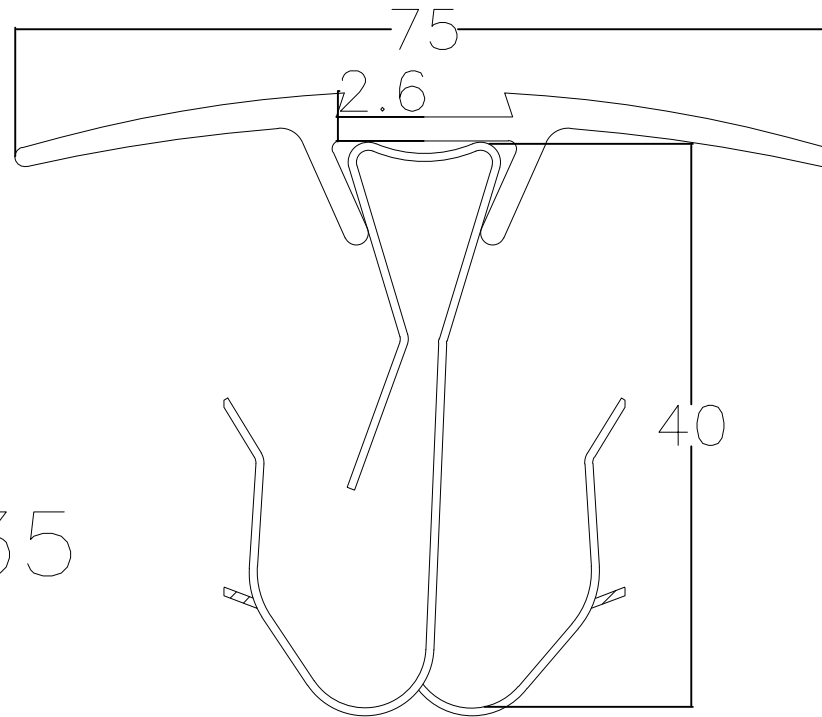

Material	Aluminum ASTM 6063 T5	DRAWING		<p style="text-align: center;">Nanjing Meishuo Building Materials Co.,Ltd</p> <p style="text-align: center;">Interior Wall Expansion Joint</p>
Thickness		CHECKING		
Colour	Clear Anodised	APPROVING		
Hardness	ASTM 6063 T5			
		Picture No.	8	